

Tax Parcel No.: 335-5.17-11.00
 Prepared by and Return to:
 Whiteford Taylor Preston LLC
 The Renaissance Centre, Suite 500
 405 North King Street
 Wilmington, DE 19801

BK: 4505 PG: 298

2015 AMENDED AND RESTATED DECLARATION OF PILOT POINT

This 2015 Amended and Restated Declaration of Pilot Point, condominium in Lewes, Delaware (the "Condominium"), is made by the unit owners, for the purpose, *inter alia*, to adopt provisions of the more modern Delaware Uniform Common Interest Ownership Act, to incorporate various judicial determinations over the Condominium's history and to address certain expansion into or modifications made to the common elements by unit owners. The 2015 Amended and Restated Declaration of Pilot Point is being adopted contemporaneous with the 2015 Amended and Restated Code of Regulations of Pilot Point and with a unit owner vote to adopt an amendment to the declaration plan.

WHEREAS, the Declaration Submitting Real Property to Provisions of Unit Property Act, 25 Del. C. § 2201, *et seq.* was duly executed on May 14, 1973 and recorded in the Office of the Recorder of Deeds in and for Sussex County, State of Delaware (the "Recorder's Office") on June 21, 1973, in Deed Book 709, Page 640 *et seq.* (the "Original Declaration"); and,

WHEREAS, the Original Declaration submitted the land and improvements to be known as Pilot Point, described in the Declaration Plan dated May 9, 1973 recorded in the Recorder's Office in Plot Book 8 at page 683 *et seq.* (the "Declaration Plan"), to the provisions of the Unit Property Act, 25 Del. C. § 2201 *et seq.*, (the "UPA") in order to create a plan of condominium ownership; and,

WHEREAS, the Code of Regulations, (the "Code of Regulations"), also dated May 14, 1973, was recorded in the Recorder's Office on June 21, 1973 in Deed Book 709, Page 658 *et seq.*; and ,

WHEREAS, pursuant to Paragraph 7 of the Original Declaration, the administration of the Condominium was to be controlled by the provisions of the Code of Regulations, which were incorporated by reference into the Original Declaration; and,

WHEREAS, an Amendment to Declaration by Asco, Ltd., Submitting Real Property to Provisions of Unit Property Act, 25 Del. C. § 2201, *et seq.*, dated March 31, 1978 was recorded in the Recorder's Office, in Deed Book 887, Page 60 *et seq.* (the "Amendment"); and,

WHEREAS, by Order of the Court of Chancery of the State of Delaware in matter of C.A. #733, 1978 and C.A. #820, 1979 dated May 16, 1984, a copy of which was recorded in the Recorder's Office on July 10, 1984 at Book 139, Page 99 *et seq.*, the Amendment and Original Declaration were further revised and amended; and,

WHEREAS, following the May 16, 1984 Order of the Court of Chancery there were a total of sixty (60) units in nine buildings and no further buildings could be constructed at Pilot Point; and,

WHEREAS, pursuant to Article III of the Code of Regulations, the owners of the units constitute the Association of Owners (the "Association"), which has the responsibility of administering the Condominium, approving the annual budget, establishing and collecting monthly assessments and arranging for the management of the Condominium; and,

WHEREAS, pursuant to Article IV of the Code of Regulations, the affairs of the Association are governed by a Council, (hereinafter "Board") vested with the powers and duties necessary for the administration of the Condominium; and,

WHEREAS, over time certain unit owners within Pilot Point made modifications to the community common elements and their units, including but not limited to enclosing decks or extending decks onto the common elements further than their original size; and,

WHEREAS, the various expansion and encroachments into the common elements have caused uncertainty about the boundary lines of units, impeded the sale of some units and made it difficult to obtain title insurance; and,

WHEREAS, the Association initiated litigation captioned as *Pilot Point Association of Owners by and through the Council of Owners for the Pilot Point Association of Owners v. Bonk, et al.*, in the Court of Chancery of the State of Delaware, C.A. No. 4717-CC (the "Bonk Litigation"), seeking, *inter alia*, to restrict and enjoin certain unit owners from making further encroachments into the common elements of the Condominium; and,

WHEREAS, by ruling dated July 31, 2009 in the Bonk Litigation, the Court found that Pilot Point lacked an enforceable restriction related to encroachment and for that same reason the Court determined it lacked authority to establish such standards; and,

WHEREAS, at the annual meetings of unit owners held on April 28, 2012, the unit owners voting overwhelmingly to authorize the Board to document the encroachments, draft the appropriate legal documents to move the association toward the Delaware Uniform Common Interest Ownership Act, Title 25, Chapter 81 (the "DUCIOA") and to prepare and coordinate the adoption of an enforceable restriction related to common element encroachments; and,

WHEREAS, seeking to document encroachments, the Association commissioned the preparation of "as-built" plans depicting buildings, additions, modifications, improvements and encroachments as currently existing in Pilot Point (the "Amended Declaration Plan"); and,

WHEREAS, the Amended Declaration Plan, dated February 16, 2015, was recorded at the Recorder's Office on March 17, 2015 as Plot No. 7784, Volume 211, Page 1; and,

WHEREAS, 25 *Del. C.* § 318(e) provides that "[a]ny covenant, restrictions, or conditions contained in a deed or declaration, including a declaration under the Unit Property Act[], for residential property which does not explicitly include a mechanism to amend the document, may hereafter be amended by a vote requiring the affirmative vote of 2/3 of the property owners"; and,

WHEREAS, the Original Declaration does not contain an explicit mechanism to amend and therefore may be amended under 25 *Del. C.* § 318(e) by an affirmative vote of 2/3 of the unit owners; and,

WHEREAS, Section 81 – 119 of DUCIOA provides that "[t]he declaration, bylaws, or plats and plans of any common interest community created before the effective date of this chapter, may be amended to achieve any result permitted by this chapter, regardless of what applicable law provided before this chapter was adopted"; and,

WHEREAS, Section 81 – 121(a) of DUCIOA provides that "[a]ny preexisting common interest community or approved common interest community has the right to amend its declaration, code of regulations, bylaws, declaration plans, or plats or plans or other governing documents, including, but not limited to certificates or articles of incorporation, formation or otherwise to comply with any or all of the requirements of

this chapter, or a preexisting common interest community or approved common interest community may select particular additional sections of this Chapter to apply to that community without adopting the entire chapter, or a preexisting common interest community may select particular additional sections of this Chapter to apply to that community without adopting the entire chapter"; and,

WHEREAS, Section 81 – 217(a) of DUCIOA, although not currently applicable to Pilot Point under DUCIOA Section 81-119, provides that the Original Declaration, including any plats and plans, may be amended only by vote or agreement of unit owners of units to which at least 67 percent of the votes in the association are allocated"; and,

WHEREAS, the unit owners of Pilot Point, while retaining the condominium ownership, seek to amend and modernize the Declaration Plan, Original Declaration and Code of Regulations to, *inter alia*, establish a procedure for adopting and amending an enforceable standard to address encroachments into the common elements as well as to adopt certain sections of DUCIOA; and,

NOW THEREFORE, more than 2/3 of the unit owners do hereby declare that they adopt the Amended Declaration Plan and declare this as the 2015 Amended and Restated Declaration of Pilot Point (the "Declaration") as follows, to wit:

1. DESCRIPTION OF LAND. The land constituting Pilot Point remains unaltered from the description set forth in the Original Declaration in Deed Book 709, Pages 641-42 and is more fully described as:

ALL that certain tract, piece or parcel of land situate, lying and being in Lewes and Rehoboth Hundred, Sussex County, Delaware, more particularly described as follows, to wit:

BEGINNING at a set concrete monument on the southwest corner of the premises which are subject to this Declaration and which lie on Lewes Beach to the North of the Northerly terminus of the Theodore Freeman Highway and South of Delaware Bay Shore; thence with lands of The City of Lewes, north 42° 56 minutes 30 seconds east, 625.00 feet to a set concrete monument; thence by the same north 42° 56 minutes 30 seconds east, 168.35 feet to a point at the mean low water line and northwest corner of the tract hereby described; thence, with the mean low water line along the southerly side of the Delaware Bay to a point, the northeast corner of the tract herein described; thence, with lands of The City of Lewes, south 42° 56 minutes, 30 seconds west, 107 feet more or less to a set concrete monument; thence by the same south 42° 56 minutes 30 seconds

west, 703.76 feet to an existing iron pipe; thence by the same south 42° 56 minutes 30 seconds west, 266.24 feet to a set concrete monument on the north side of Cape Henlopen Drive and marking the southeast corner of the tract herein described; thence, with Cape Henlopen Drive north 86° 53 minutes, 12 seconds west, 998.22 feet to a set concrete monument to place of beginning, containing 17.35 acres, more or less, all as per survey of Vandemark & Lynch, Inc. dated February 16, 1972.

2. DESCRIPTION OF BUILDINGS. The nine buildings erected upon the property are divided into two (2) phases. Phase I is comprised of thirty-two (32) units in five buildings as they are each identified in Article 5 below. Each of the Phase I units numbering 1 through 32, located in Buildings 1 through 5, consist of an enclosed space designed as a single family dwelling having access to a public way or through fair by way of common elements. All Phase I units are of wooden frame construction on wooden piling. Each of the buildings has siding and each of the units originally had a screened porch and an open patio. Each of the Phase I units originally had two and one-half (2-1/2) baths, three (3) bedrooms, a living-dining area and a kitchen area. Building 1, containing Units 1 through 5, and Building 2, containing Units 6 through 11, as shown on the Amended Declaration Plan are considered "Type B" Units. Buildings 3, 4 and 5, each containing seven units, numbering Units 12 through 32, as shown on the Amended Declaration Plan, are considered "Type A" Units. Phase II is comprised of twenty-eight (28) units in four buildings as they are each identified in Article 5 below. Each of the Phase II Units consists of an enclosed space designed as a single family dwelling having access to a public way or through fare by way of common elements. All units are of wooden frame construction with siding. Buildings 6 and 7, containing Units 33 through 46, as shown on the Amended Declaration Plan, are a "Type C" Unit erected on wood pilings, and consists of living-dining area, kitchen area, three (3) bedrooms, a den and two and one-half (2 1/2) bathrooms. Buildings 8 and 9, containing Units 47 through 60, as shown on the Amended Declaration Plan, are a "Type D" Unit erected on a cement pad, and consists of a living-dining area, kitchen area, three (3) bedrooms, and two (2) bathrooms. The Original Declaration allowed for the construction of only eight buildings. No further buildings or units may be added.

3. DESCRIPTION OF UNITS. The condominium known as Pilot Point shall consist of sixty (60) units as they are identified in Article 5 below. Each unit shall consist of an enclosed space designed as a single-family dwelling having access to a public way or thoroughfare by way of the common elements. All walls, windows and doors, including frames of both, located within a unit are part of the unit. Appliances, plumbing pipes and fixtures, heating, ventilation and air conditioning systems,

telephone lines, electrical lines and equipment in the unit or serving only that unit are part of the unit. All of the above is more fully shown by reference to the Amended Declaration Plan, dated February 16, 2015, recorded among the plot records of Sussex County, Delaware on March 17, 2015 as Plot No. 7784, Volume 211, Page 1. The Original Declaration allowed for the construction of only eight buildings. No further Units may be added.

4. DESCRIPTION OF COMMON ELEMENTS. The common elements and limited common elements shall be as follows:

a. All of the land described in Paragraph 1 above not occupied by Phase I and Phase II units, and subject to an easement extending along Cape Henlopen Drive over, across, through and under the lands herein submitted to the Unit Property Act of the State of Delaware, as more particularly set forth in an Agreement of Lease by and between Commissioners of Lewes and Match Land Co. dated September 29, 1967, to be used for sanitary and storm sewer, water and electric poles and transmission lines and an existing lift station. Said easement is described in the lease referred to above and is of record in the Office of the Recorder of Deeds, in and for Sussex County, in Deed Book 624, at page 527;

b. The driveway, parking areas and sidewalks shall be general common elements;

c. The individual walkways leading into each of the individual units is limited common element, all other walkways are general common elements;

d. The roof, including framing therefor and the supporting posts as well as venting and sewer piping interfaces/fixtures, shall be general common elements;

e. The foundation, the piling, all supporting posts and beams located under the building shall be general common elements;

f. The enclosed space under the unit located between the building sections supported by creosote pilings and the ground is limited common elements;

g. Any attic space above a unit is limited common elements;

h. The electrical wiring system, including transformers and all other equipment used to distribute electricity from the main electrical panel or meter to the electrical panel inside any individual unit, but not including any fixture inside or on the exterior of any wall within any of the individual units or any meter or electrical system from the meter serving any individual unit, shall be general common elements;

i. The outside exterior walls of the buildings shall be general common elements unless such walls have been modified by the unit owner which such modification or addition shall be limited common element;

j. The sanitary sewage facilities from the lateral line to the city connection shall be general common elements for Unit Types A, B and C. The sanitary sewage facilities from the point it enters the concrete slab to the city connection shall be general common elements for Unit Types D;

k. All lighting facilities, equipment and wiring installed to illuminate any of the general common elements;

l. The party walls located between the various units shall be general common elements, reserved for the units adjoining the party wall;

m. The outside steps and small decking and any handrail leading to the entrances of a unit shall be limited common elements reserved for the units they serve;

n. Any fence, whether on the outer property boundaries or utilized for sand/wind control shall be general common elements;

o. Wooden walkways from the parking areas to the beach between Units 11-12, 18-19, 25-26 32-33 and 39-40;

p. Encroachments by the perimeter walls, ceilings, and floors surrounding each condominium unit on another unit or on common elements or of common elements on any units caused by the settlement or movement of the building or caused by minor inaccuracies in building or rebuilding which now exist or hereafter exist, and such encroachments shall continue until such encroachment no longer exists;

q. The tennis courts;

r. Unit owner additions or modifications to the common elements, including but not limited to decks and enclosed porches, as depicted on the Amended Declaration Plan shall be limited common elements reserved for the units they serve.

All areas designated as limited common elements are reserved for the exclusive use of the unit owner(s) of the unit(s) to which they are declared to be appurtenant to by appropriate designation in this Declaration or on the Amended Declaration Plan. If no such designation is made in this Declaration or on the Amended Declaration Plan, then the limited common elements shall be deemed to be appurtenant to unit(s) to which they are adjacent or which they are rationally intended to serve and benefit.

5. PERCENTAGE OF INTERESTS. As established by the May 16, 1984 Order of the Court of Chancery, the units in Phases I and II of Pilot Point shall have the percentages of interest in the condominium common elements set forth below:

Phase I		Phase II	
<u>Unit No.</u>	<u>Percentage</u>	<u>Unit No.</u>	<u>Percentage</u>
1	1.5087	33	1.8649
2	1.5087	34	1.8649
3	1.5087	35	1.8649
4	1.5087	36	1.8649
5	1.5087	37	1.8649
6	1.5087	38	1.8649
7	1.5087	39	1.8649
8	1.5087	40	1.8649
9	1.5087	41	1.8649
10	1.5087	42	1.8649
11	1.5087	43	1.8649
12	1.6839	44	1.8649
13	1.6839	45	1.8649
14	1.6839	46	1.8649
15	1.6839	47	1.5668
16	1.6839	48	1.5668
17	1.6839	49	1.5668
18	1.6839	50	1.5668
19	1.6839	51	1.5668
20	1.6839	52	1.5668
21	1.6839	53	1.5668
22	1.6839	54	1.5668
23	1.6839	55	1.5668
24	1.6839	56	1.5668
25	1.6839	57	1.5668
26	1.6839	58	1.5668
27	1.6839	59	1.5668
28	1.6839	60	<u>1.5668</u>
29	1.6839	Total	<u>100.00*</u>
30	1.6839		
31	1.6839		
32	1.6839		

*Rounded from 100.0014 to 100%.

6. CHANGE IN PERCENTAGE OF OWNERSHIP IN COMMON ELEMENTS VOTING RIGHTS AND COMMON EXPENSES OR PROFITS. Notwithstanding the provisions of Paragraph 5 of this Declaration, the proportionate undivided interest in any common element by any one or more unit owner or owners may be altered, amended, reduced, increased or changed by the recording of an amendment to this Declaration duly executed by all unit owners affected by such

changes pursuant to the provisions of 25 Del. C. §2205 and 25 Del. C. §2219(6), as amended.

7. ADMINISTRATION OF PROPERTY. The administration of this Condominium as described herein shall be pursuant to the provisions of this Declaration and the Code of Regulations which are incorporated herein by reference as though fully set out. A plan of condominium ownership is hereby constituted under and subject to the provisions of the Unit Property Act, Title 25, Chapter 22, as amended, and the Delaware Uniform Common Interest Ownership Act, Title 25, Chapter 81, as amended, so that the various units may be capable of independent use, on account of each unit having its own entrance and exit from and to a common area and facility of the project, each unit owner or owners having an exclusive and particular right over the respective unit and in addition, the specified undivided interest in the common elements and facilities and/or limited common elements and facilities pursuant to the aforesaid statute. By the 2015 Amended and Restate Declaration, the Condominium, submits to the following additional provisions of the Delaware Uniform Common Interest Ownership Act, Title 25, Chapter 81: 81: 217(a), (b) and (j); 302(a)(9)-(10), (c) and (e); and 308A(c), (e), (f) and (g).

8. COMMON ELEMENTS. The general and/or limited common elements and facilities shall remain undivided, and no unit owner or owners shall bring any action for partition or division except as provided by 25 Del. C. §2239. The undivided interest in the general and/or limited common elements and facilities shall not be separated from the unit to which it pertains and shall be deemed conveyed, leased, or encumbered with the unit even though such interest is not expressly mentioned or described in the conveyance or other instrument as provided in 25 Del. C. §2205.

9. COMPLIANCE WITH AND ENFORCEMENT OF REGULATIONS. Each unit shall be restricted to use for residential purposes only. Each unit owner or owners shall comply with the provisions of this Declaration, the Code of Regulations, decisions and resolutions of the Board, as lawfully amended from time to time, and failure to comply with any such provisions, decisions or resolutions, shall be grounds for an action to recover sums due, for damages, or for injunctive relief, as provided by 25 Del. C. §2210 or any other law of this State.

No owner or owners of a unit may be exempt from liability for the contribution towards the common expenses by waiver of the use or enjoyment of any of the general and/or limited common elements and facilities, or by the abandonment of the unit.

All present or future owners, lessees, tenants, future tenants, or any other person or persons that might use the facilities of the project in any manner, are subject to the provisions of this Declaration and the mere acquisition or rental of any of the units of the project, or the mere act of occupancy of any of said units, shall signify that the provisions of this Declaration are accepted and ratified.

For the purpose solely of performing any of the repairs or maintenance required or authorized by this Declaration, or in the event of a bona fide emergency involving illness or potential danger to life or property, the Association, through its duly authorized agents or employees, shall have the right, after reasonable efforts to give notice to the owner or occupant, to enter any condominium unit at any hour considered to be reasonable under the circumstances. A unit owner or lessee shall grant access to his unit to the Board of Directors for the purpose of investigating and making inspections related to compliance with this Declaration, the Code of Regulations and Rules and Regulations of the Association and, as necessary, for insurance purposes. In the event of entry to a unit without prior consent of the owner or lessee, a report stating the nature, purpose and time of such entry, the names of all persons who participated in the entry to such unit and a statement detailing the steps taken to secure entry by permission shall be filed with the Secretary within three business days of the occurrence. A copy of said report shall be furnished to the owner or lessee of the unit.

The cost of the maintenance or repair of any condominium unit or limited common elements in the event such maintenance or repair is reasonably necessary in the discretion of the Board of Directors to protect the common elements or to preserve the appearance or value of the condominium project, or is otherwise in the interest of the general welfare of all owners of the condominium units is the responsibility of the unit owners from which the repair necessitated. By way of example, a leaking unit element like a window causing water intrusion and damage to a common element may be repaired by the Association and costs billed to the unit owner.

10. REMOVAL FROM CONDOMINIUM OWNERSHIP. The dedication of the property to the plan of condominium ownership, herein shall not be revoked, or the property removed from the plan of condominium ownership or any of the provisions herein amended, unless all of the lessees, owners and mortgages of all of the mortgages covering the units unanimously agree to such revocation, or amendment or removal of the property from the plan by duly recorded instruments. If the property subject to the plan of condominium ownership is totally or substantially damaged or destroyed, the repair, reconstruction or disposition of the property shall be as provided by 25 Del. C. §2239.

11. MORTGAGE LIENS. Except for the rights granted to the Association under DUCIOA §81-316, where a mortgagee or other purchaser or purchaser of a unit obtains title by reason of foreclosure of a mortgage covering a unit, such acquirer of title,

their heirs, executors, administrators successor or assigns, shall not be liable for assessments by the Association which became due prior to the acquisition of title by such acquirer, it being understood, however that the above shall not be construed to prevent the Association from filing and claiming a lien for such assessments and enforcing the same as provided by law in 25 Del. C. 2236 and 25 Del C. §81-316, and any amendments and supplements thereto, but that such assessment liens shall be subordinate to such mortgage.

12. INSURANCE.

(a) Protective Policies. The Board, with the approval of a majority of the unit owners, shall procure and maintain, in its name, as agent or trustee for the benefit of the unit owners who shall be deemed parties insured, policies of insurance in stock insurance companies licensed to do business in the State of Delaware, to the extent obtainable, as follows:

(1) A policy or policies insuring the building, including exterior glass against loss, damage or destruction by fire or other casualty, including lightning, windstorm, hail, explosion, aircraft, vehicle, falling object, smoke, malicious mischief, vandalism, collapse through weight of snow, ice or sleet, water, and other similar casualty, in an aggregate amount equal to the full insurable replacement value of the building, without regard to depreciation and excluding improvements to units or any additions/alterations to the common elements made by the owners. The policy or policies, unless otherwise insuring the condominium units against loss, damage or destruction, shall have a contingent or conditional endorsement, with limits equal to the replacement value of the condominium units, providing for payment by the insurer of a sum sufficient for restoration of each unit to a tenantable condition, in the event that the owner thereof shall fail or refuse to restore his unit within a reasonable time after loss, damage or destruction of such unit, by fire or other casualty insured against it. In lieu of the foregoing insurance, the Board may procure and maintain such other insurance against loss, damage or destruction of the common elements and the condominium units, as shall give substantially equal or greater protection to the unit owners, as their interest may appear.

(2) Such insurance as will protect the Board of unit owners, and each unit owner, from claims under Workman's Compensation Acts and other employee benefit acts.

(3) Such insurance as will protect the Board and each unit owner from claims for damage because of bodily injury, including death, to all other, including employees of the insured, and from claims for damage to property, any or all of which may arise out of or result from ownership or leasing of any interest in the condominium project or the management or operation of said project, or because of any injury or damage sustained on or attributable to the property, including the ownership, maintenance and use of the parking areas outside the building. It is intended that the insurance described in this subparagraph be a comprehensive general liability policy endorsed to protect each unit owner and the members of the Condominium Board

against all liability arising out of or otherwise attributable to the property, including operation of the premises, products liability, liability attributable to work or other act of an independent contractor, or let or sublet work, landlords-tenants liability, and contractual liability. Further, the insurance shall cover the liability of one or more unit owners as parties insured to one or more of the remaining unit owners, though also parties insured. Such public liability insurance shall be in the limits of at least \$100,000.00 for injuries or damages sustained by any one person, \$300,000.00 for injuries or damages sustained by two or more persons in any one accident, and \$25,000.000 for property damage. The public liability insurance policy or policies shall be so endorsed as to protect the insured against liability imposed or assumed by any contract.

(4) In all events, to the extent obtainable, each policy or policies of insurance, under this Section, shall contain a waiver of the insurer's subrogation rights against each unit owner, and a waiver of any defense maintainable by the insurer by reason of any co-insurance provision of any policy or policies, or by reason of any act or neglect of any unit owner whether before or after the loss, damage or destruction may occur. Further, each policy or policies of insurance shall provide that any unit owner in his own right, may procure other insurance, fire, casualty, liability or otherwise and that such other insurance shall in no wise serve to reduce, abate, diminish or cause any proration in payment of the total loss by the insurer. Each policy or policies of insurance procured under paragraphs (1) or (2) of this Section shall state that the exclusive right and authority to adjust losses under the policy shall be vested in the Board. Nothing provided in this Section shall prejudice the right of any unit owner or owners to insure his condominium unit on his account and for his own benefit, or to insure himself against liability to others. If the unit owners, however, shall procure fire or other casualty insurance covering his condominium unit or his interest in the Condominium Project, he shall file with the Board a duplicate of the insurance policy.

Nothing provided in this Section shall prejudice the right of any unit owner or owners to insure his condominium unit on his account and for his own benefit, or to insure himself against liability to others. If the unit owners, however, shall procure fire or other casualty insurance covering his condominium unit or his interest in the Condominium Project, he shall file with the Board a duplicate of the insurance policy.

(b) Repairs and Replacement. If the building is damaged and such damage is less than substantial total destruction, the proceeds of any insurance policy or policies procured under the provisions of paragraph (1) or (2) of this Section shall be applied to repair, restore and reconstruct the unit and common elements damaged by the casualty insured against. If the proceeds of insurance are insufficient to cover the cost of any necessary repair, replacement or restoration of the units and common elements, so damaged, such excess costs shall be paid by the Condominium Board as a common expense, upon special assessment therefor and levy thereof by the Board against each unit owner directly affected thereby in proportion with his undivided interest of the common elements.

(c) Disbursement of Insurance Proceeds. Disbursement of insurance proceeds received because of substantially total destruction of the building shall be governed by 25 Del. C. §2239.

(d) Deductible.

(1) In the event of insured casualty damage to any portion of the Property, where the total cost of repairing the damage is greater than the deductible amount under the master property damage insurance, the damage shall be repaired by the Board, subject to the special provision set forth in this section, under which a unit owner is responsible for repair or reimbursement.

(2) Deductible amounts under the master property damage insurance shall be common expenses, provided, however, that, with respect to any master insurance claim for casualty damage that originated in a unit, the unit owner where the damage originated shall be responsible for the deductible payable under the master property damage insurance. The Condominium shall have no responsibility to and will not repair any interior damage to a unit, except to the extent such damage is covered, above the deductible, by the insurance maintained by the Condominium.

(3) If damage is caused by negligence, misuse or neglect, the unit owner of the unit occupied by the person whose negligence, misuse or neglect caused the damage shall reimburse the Condominium for the full deductible amount under any master property damage insurance claim, as well as for any other amounts paid by the Board in connection with such damage that are not covered by the proceeds of the master property damage insurance. The Board may demand reimbursement from the unit owner before proceeding with repairs.

13. RESTRICTIONS.

(a) The individual units in this condominium shall be used for residential purposes only; however, such use shall be construed to include temporary or vacation residence and shall not in any way preclude the rental or lease of such units by any owner or owners thereof for any term or duration. No Impact Home Based Businesses, as defined by Local or State laws, shall also be permitted. Supplemental Rules respecting the use of the units may be made as provided in the Code of Regulations.

(b) Prior to this 2015 Amended and Restated Declaration of Pilot Point, numerous owners made changes and additions to the common elements, including but not limited to larger decks and enclosed patios. The Amended Declaration Plan, which reflects those changes to the common elements, has been approved by the Association and recorded in an effort to document the extent of those modifications. After the recording of this 2015 Amended and Restated Declaration of Pilot Point, a unit owner shall not change the exterior appearance of the common elements adjacent to his unit or any part of the unit visible from outside of the unit (i.e. doors and windows) and other limited common elements, in any manner or fashion, adding additions, decks or fixtures thereto, or otherwise, without obtaining the prior written approval of the Board. The

Board shall review proposed alterations for compliance with the "Standards for Additions", attached hereto as Exhibit A. Any additions or modifications to the common elements made by unit owners pursuant to this section shall become limited common elements.

(c) Nothing shall be altered or constructed in or on or removed from the common elements, except upon the written consent of the Board. Any alterations, construction or objects, vegetation or things placed in, on or affixed to the common element by a unit owner may be removed by the Association without notice or compensation to the unit owner.

14. MEMBERS OF BOARD. The names and addresses of the first members of the Board, to serve until their successors are chosen and qualified pursuant to the Code of Regulations, incorporated herein by reference and made a part hereof as though fully set out, are as follows

<u>NAME</u>	<u>ADDRESS</u>
<u>1. Daniel G. Anderson</u>	<u>Rehoboth Beach, Delaware</u>
<u>2. Paul C. Stokes</u>	<u>Rehoboth Beach, Delaware</u>
<u>3. James Winchester</u>	<u>Rehoboth Beach, Delaware</u>

15. EASEMENTS. Condominium units shall be subject to and burdened with the following easements:

(a) Ingress and Egress through all common elements by persons lawfully using or entitled to the same; and

(b) Entry for maintenance, repair and replacement through and into condominium units and common elements for the necessary repair of said condominium units and common elements as determined by the Board, when the same appears necessary for the public safety, or to prevent damage to any property of the project other than such units; and

(c) Structural support for all portions of condominium units contributing to the structural support of the common elements, other condominium units, or the project as a whole; and

(d) Utility easements, including but not limited to conduits, ducts, piping, wiring, and other facilities providing utility services to the various condominium units and common elements.

16. RIGHT OF THE OWNERS. Every unit owner or owners shall have the right to keep, maintain, use, operate, repair and replace: (a) his unit, in its original position, and in every subsequent position to which it changes by reason of the gradual forces of nature and of the elements, whether such subsequent position be, in whole or part, adjacent, subjacent or superjacent to said original position; (b) every chimney, stack

or vent, if originally installed by the builder of said unit; (c) every threshold, screen door, storm window, shutter, hood and hardware pertaining thereto; (d) every rain gutter, down spout, roof overhang, and exterior wall light, if originally installed by the builder of the unit.

17. LEASEHOLD INTEREST AND OPTION TO REDEEM. Nothing stated herein shall deny a unit owner, or the Association, the ability to negotiate for the renewal of any leasehold interest appurtenant to the condominium units. Notwithstanding the language of any lease, each unit owner remains obligated to pay assessments to the Association and obligations to governmental authorities for their condominium unit.

18. AMENDMENT TO DECLARATION. This Declaration may be amended by the affirmative vote of unit owners representing at least at least 67 percent of the votes in the Association at any meeting of the members duly called for such purpose in accordance with the requirements of the DUCIOA and the Code of Regulations. Voting shall be by percentage interest as defined in Article II, Section 1 of the Code of Regulations. Any amendment will be effective only upon the recordation of the same among the Land Records. Amendments may be proposed by the Board or by petitions signed by members representing thirty percent (30%) of the percentage interests in the condominium project. A description of any proposed amendment shall accompany the notice of any regular or special meeting at which such proposed amendment is to be voted on.

19. RECITAL. All of the recitals contained above in the WHEREAS clauses are incorporated herein by reference.

IN WITNESS WHEREOF, pursuant to 25 Del. C. § 318(e), the Association, acting through its Council, verifies that at least 67 percent of the votes in the Association have voted in favor of this 2015 Amended and Restated Declaration of Pilot Point. The Association hereby makes and files this 2015 Amended and Restated Declaration of Pilot Point, dated this 21st day of January, 2016.

Leslie E. McElwain

Association of Owners of Pilot Point Condominium

By: *Edward Kingman, Jr.* (seal)
Edward Kingman, Jr., President

Attest: *Mark Gatanas* (seal)
Mark Gatanas, Secretary

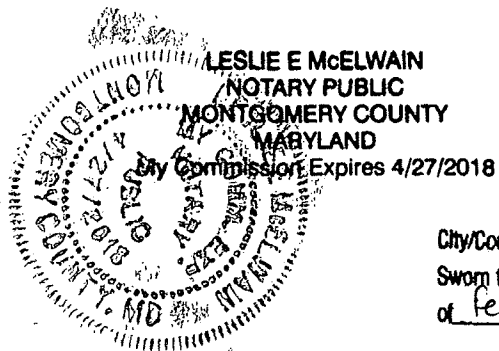

City/County of Fairfax Commonwealth/State of VA
Sworn to and subscribed before me this 1st day
of February, 2016. Witness my hand and official seal.
Sara James
(For Mark Gatanas only) Notary Public

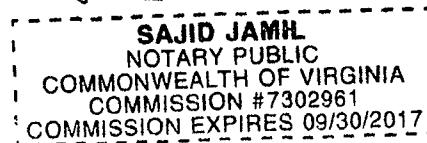
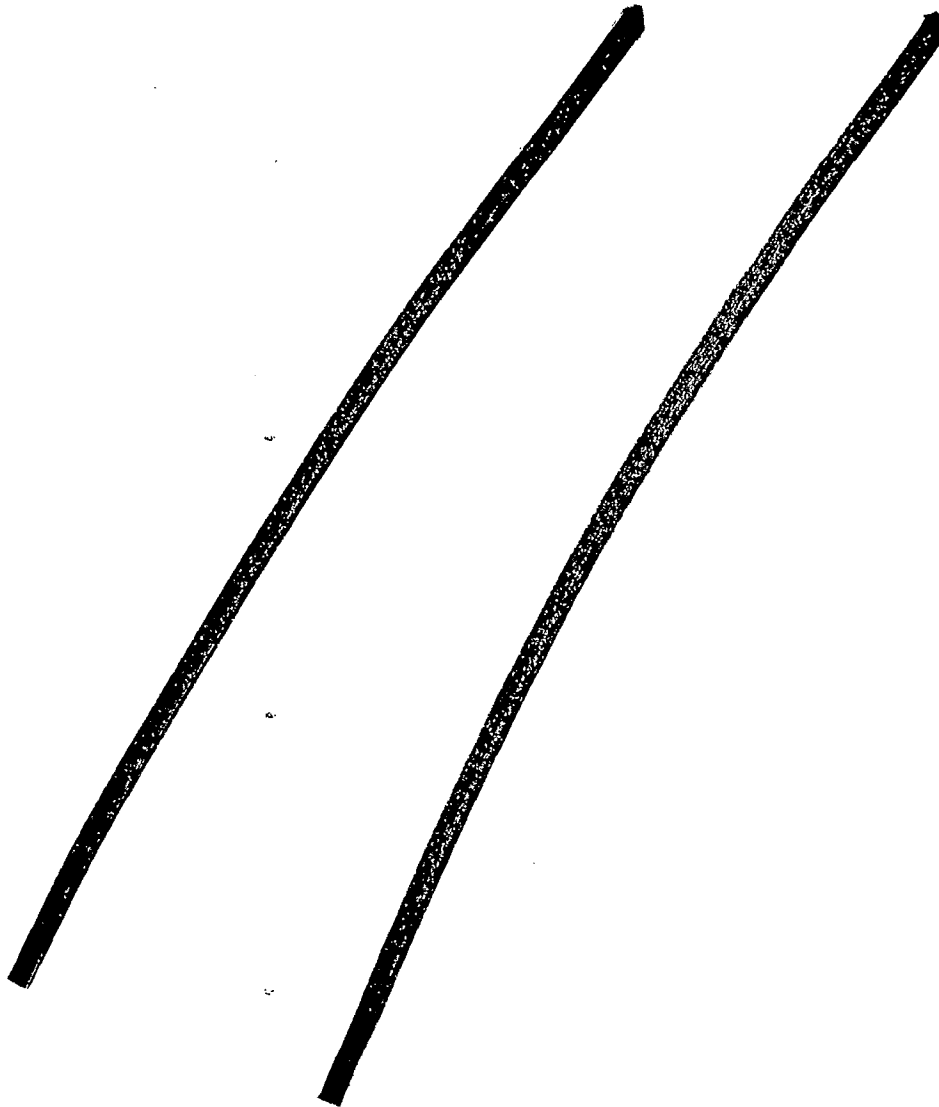
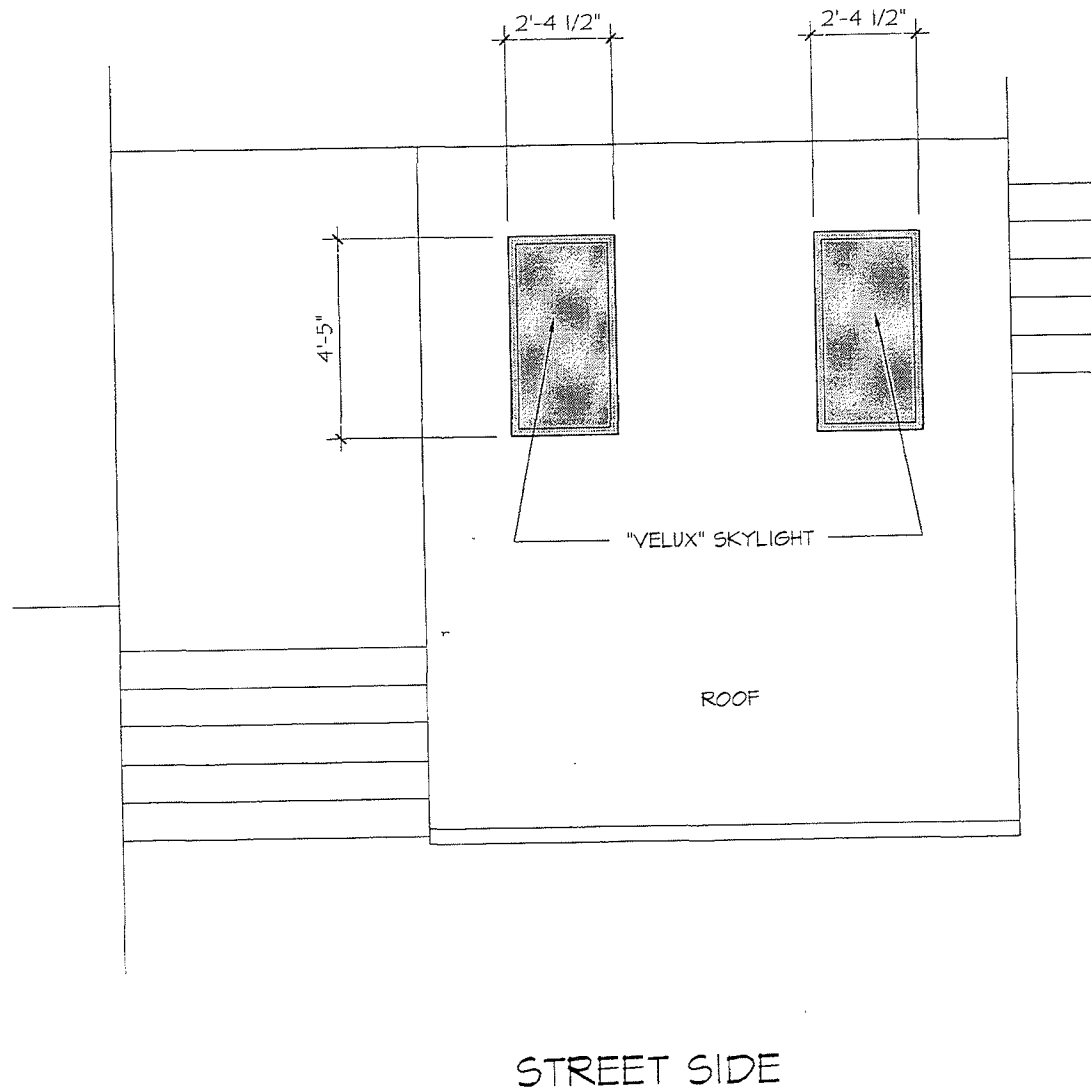

EXHIBIT A
STANDARDS FOR ADDITIONS



BK: 4505 PG: 315



STANDARDS FOR ADDITIONS EXHIBIT A	
UNITS #1 -32	SCALE 1/4" = 1'-0"
STREET SIDE DECK ENCLOSURE ROOF SKYLIGHTS	DATE 12/05/2015

BK: 4505 PG: 316

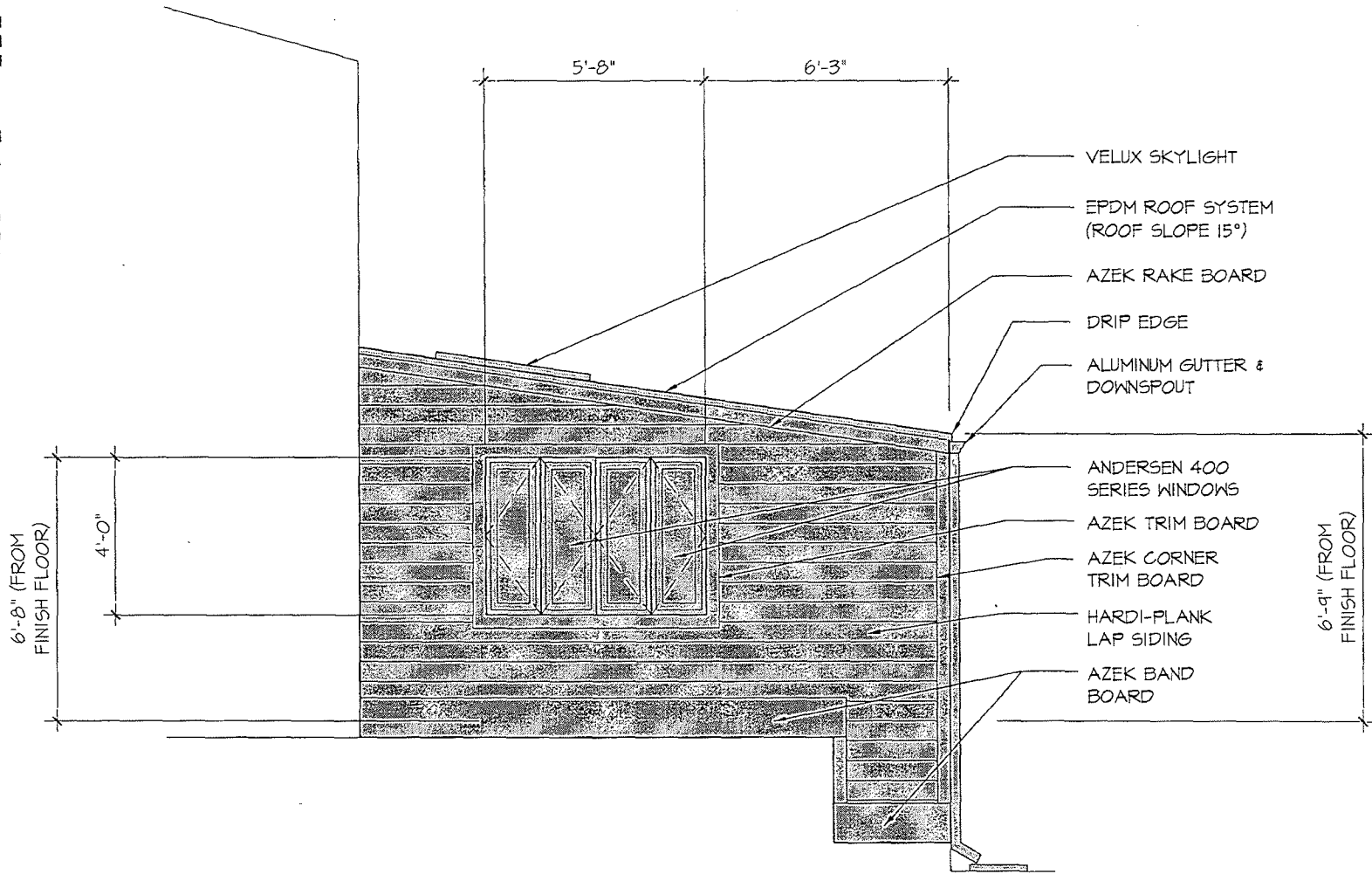

STANDARDS FOR ADDITIONS
EXHIBIT A

UNITS #1 -32

STREET SIDE DECK ENCLOSURE EPDM ROOF - OPTION I

SCALE: 1/4" = 1'-0"
DATE: 10/29/03

- VELUX SKYLIGHT
- EPDM ROOF SYSTEM
(ROOF SLOPE 15°)
- AZEK FASCIA BOARD
- DRIP EDGE
- ALUMINUM GUTTER &
DOWNSPOUT
- AZEK CORNER
TRIM BOARD
- HARDI-PLANK
LAP SIDING
- AZEK TRIM BOARD
- HARDI-PANEL
DOOR
- AZEK BAND
BOARD

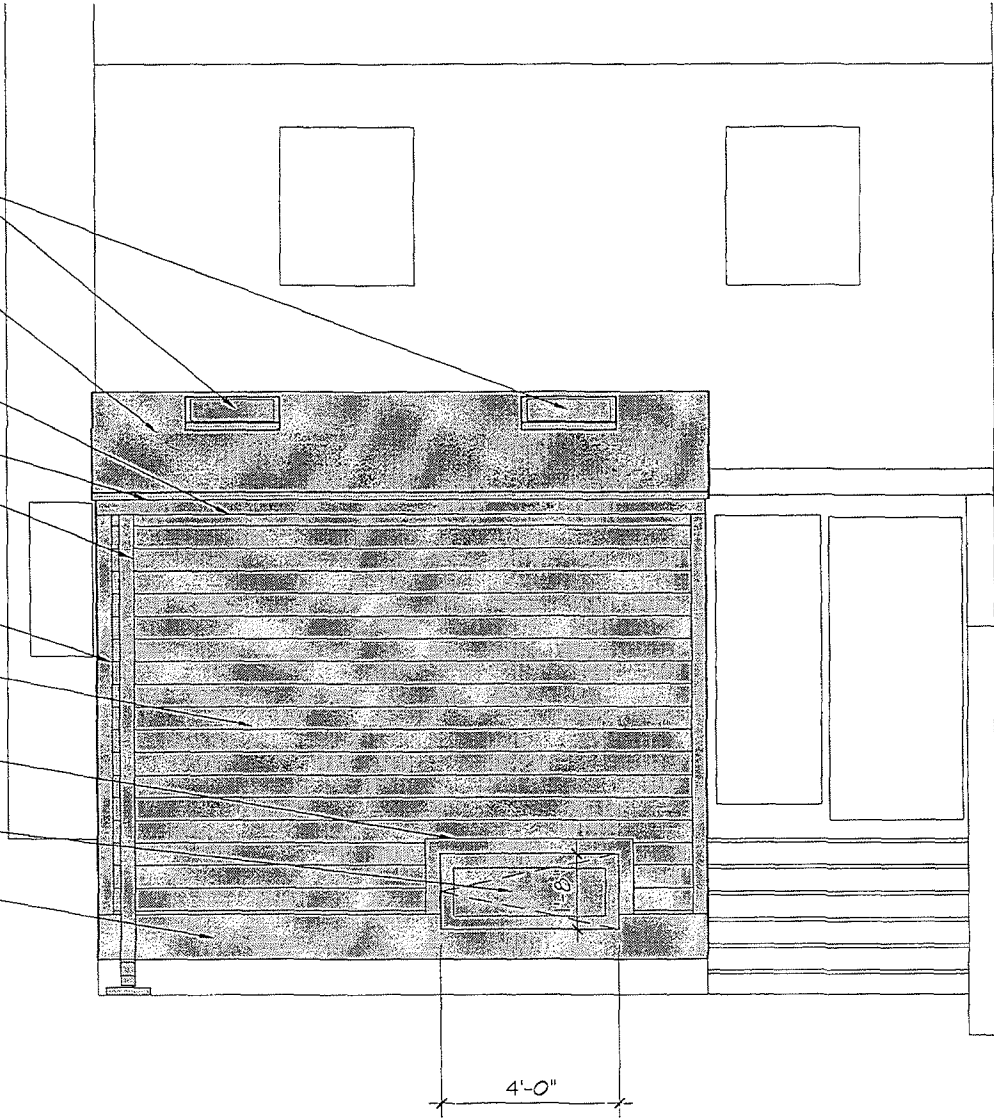

STANDARDS FOR ADDITIONS
EXHIBIT A

UNITS #1 -32
STREET SIDE DECK ENCLOSURE EPDM ROOF - OPTION 1

SCALE: 1/4" = 1'-0"
DATE: 12/02/2015

BK: 4505 PG: 318

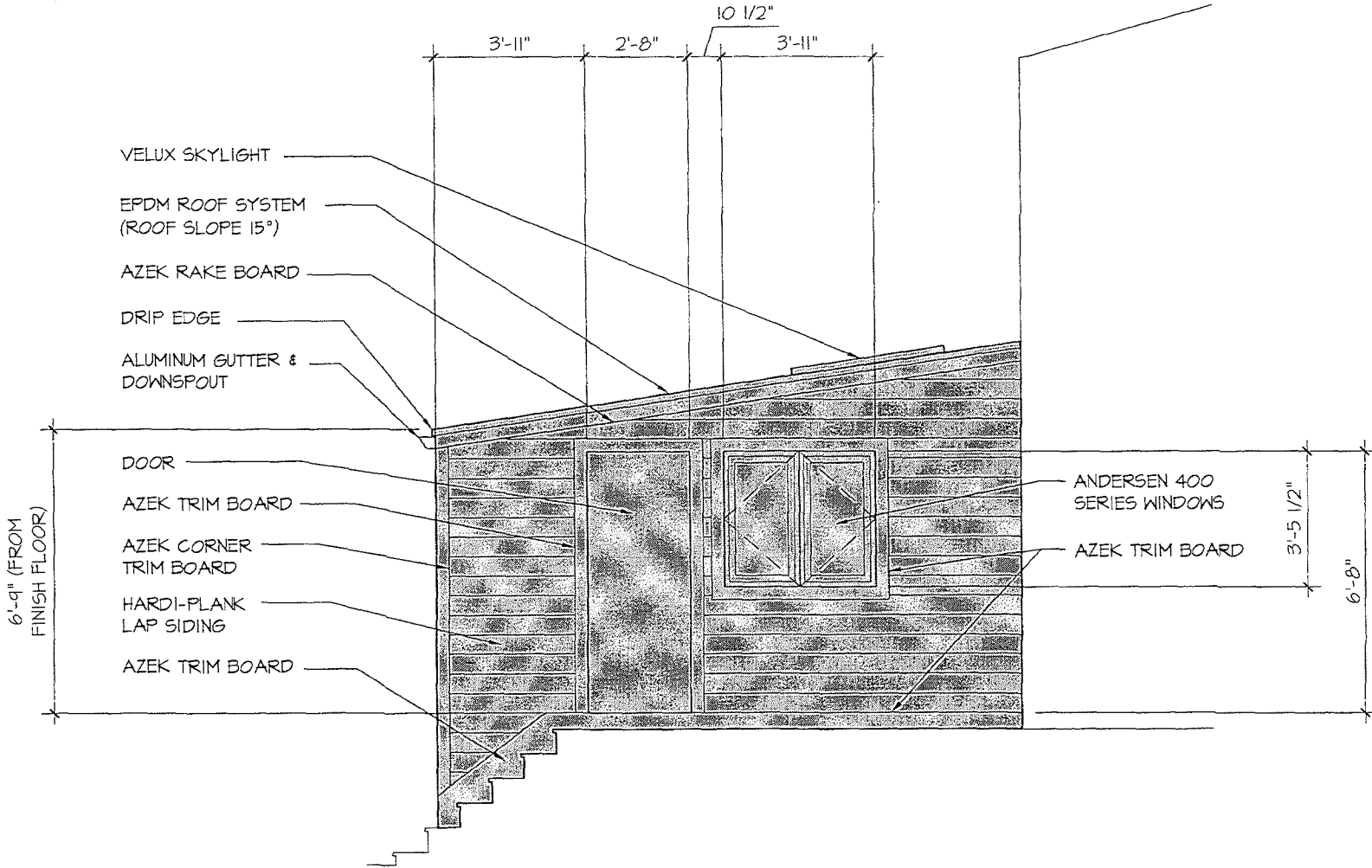

STANDARDS FOR ADDITIONS	
EXHIBIT A	
UNITS: #1 -32	SCALE: 1/4" = 1'-0"
DATE: 12/29/2003	
STREET SIDE DECK ENCLOSURE EPDM ROOF - OPTION 1	

BK: 4505 PG: 319

6'-8" (FROM FINISH FLOOR)

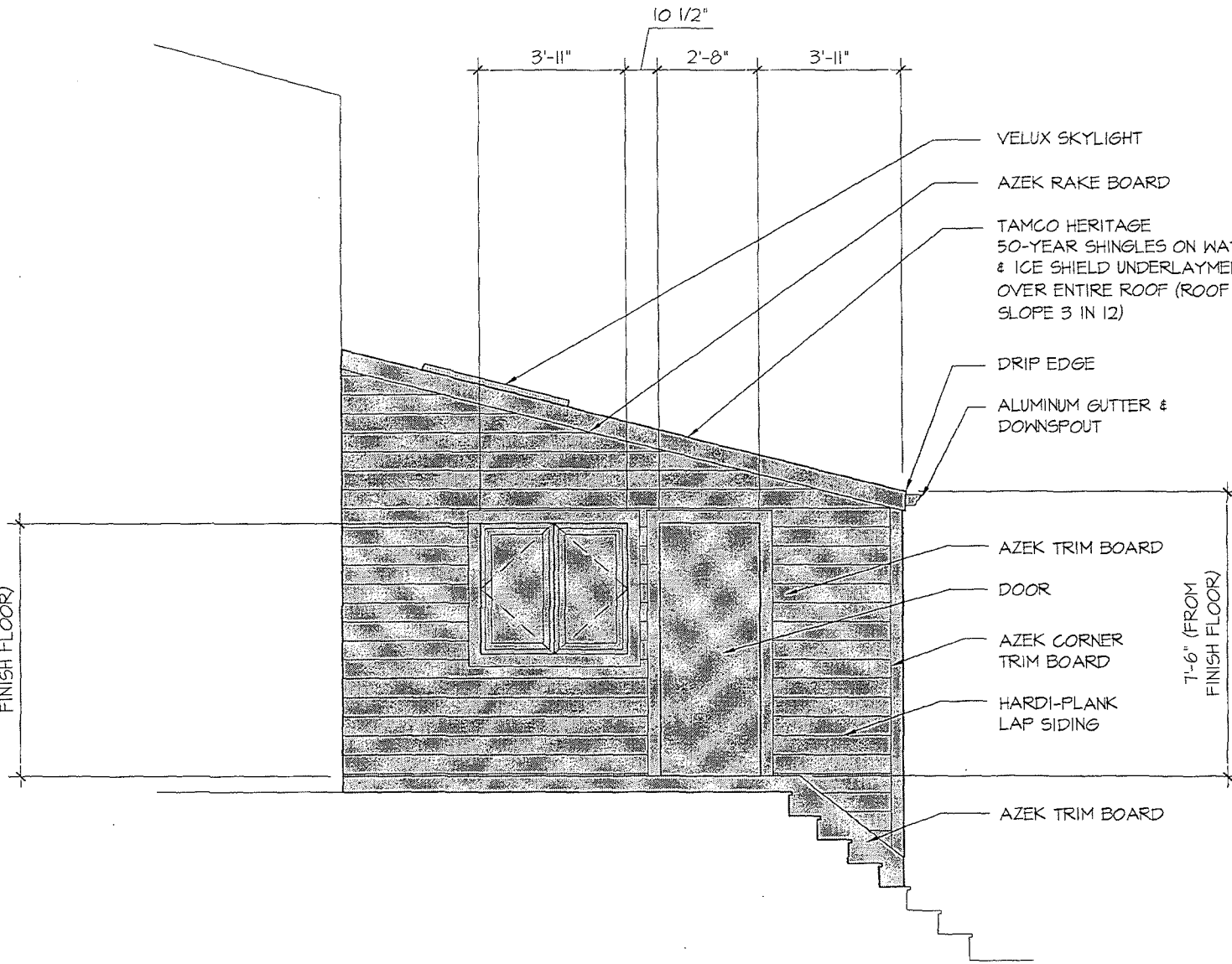

VELUX SKYLIGHT
AZEK RAKE BOARD
TAMCO HERITAGE
50-YEAR SHINGLES ON WATER
& ICE SHIELD UNDERLAYMENT
OVER ENTIRE ROOF (ROOF
SLOPE 3 IN 12)

DRIP EDGE
ALUMINUM GUTTER &
DOWNSPOUT

AZEK TRIM BOARD
DOOR
AZEK CORNER
TRIM BOARD
HARDI-PLANK
LAP SIDING

AZEK TRIM BOARD

7'-6" (FROM FINISH FLOOR)

STANDARDS FOR ADDITIONS
EXHIBIT A

SCALE: 1/4" = 1'-0"
DATE: 12/05/2015

UNITS: #1 -#2
STREET SIDE DECK ENCLOSURE SHINGLE ROOF - OPTION 2

BK: 4505 PG: 320

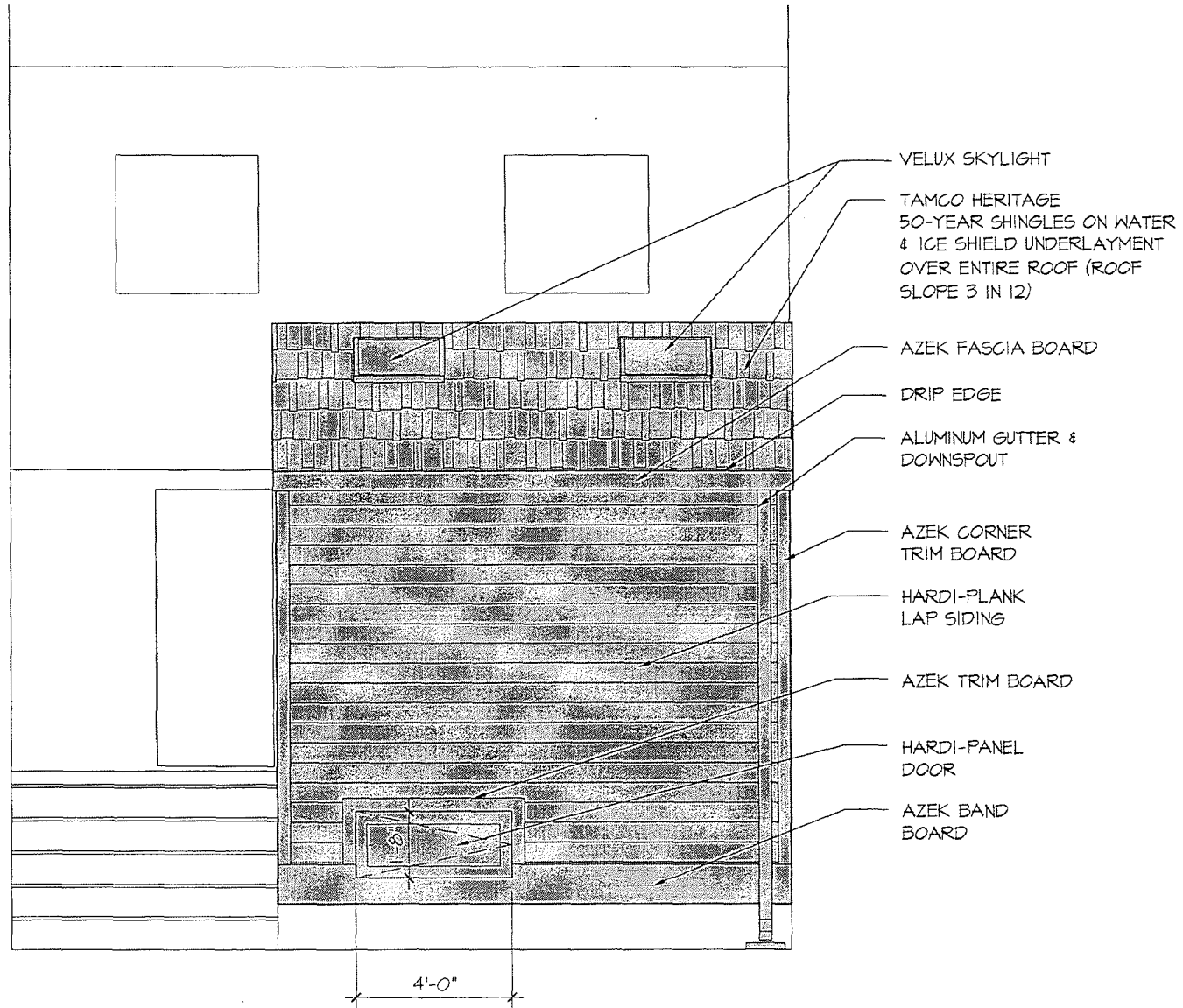

- VELUX SKYLIGHT
- TAMCO HERITAGE 50-YEAR SHINGLES ON WATER & ICE SHIELD UNDERLAYMENT OVER ENTIRE ROOF (ROOF SLOPE 3 IN 12)
- AZEK FASCIA BOARD
- DRIP EDGE
- ALUMINUM GUTTER & DOWNSPOUT
- AZEK CORNER TRIM BOARD
- HARDI-PLANK LAP SIDING
- AZEK TRIM BOARD
- HARDI-PANEL DOOR
- AZEK BAND BOARD

STANDARDS FOR ADDITIONS
EXHIBIT A

UNITS #1 -32
SCALE: 1/4" = 1'-0"
DATE: 12/01/2005

STREET SIDE DECK ENCLOSURE SHINGLE ROOF - OPTION 2

BK: 4505 PG: 321

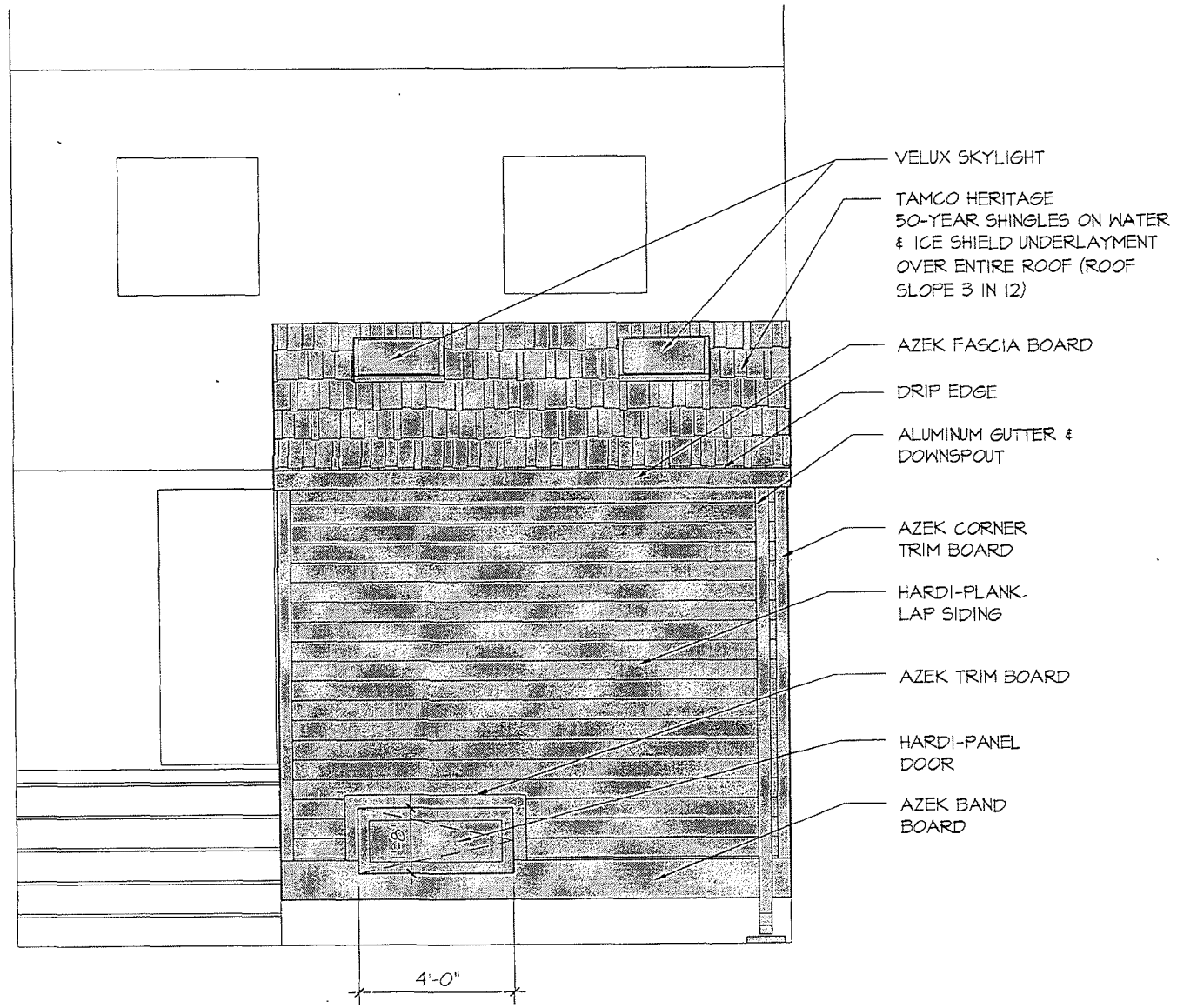

- VELUX SKYLIGHT
- TAMCO HERITAGE 50-YEAR SHINGLES ON WATER & ICE SHIELD UNDERLAYMENT OVER ENTIRE ROOF (ROOF SLOPE 3 IN 12)
- AZEK FASCIA BOARD
- DRIP EDGE
- ALUMINUM GUTTER & DOWNSPOUT
- AZEK CORNER TRIM BOARD
- HARDI-PLANK LAP SIDING
- AZEK TRIM BOARD
- HARDI-PANEL DOOR
- AZEK BAND BOARD

STANDARDS FOR ADDITIONS
EXHIBIT A

UNITS #1 -32
SCALE: 1/4" = 1'-0"
DATE: 12/09/2005

STREET SIDE DECK ENCLOSURE SHINGLE ROOF - OPTION 2

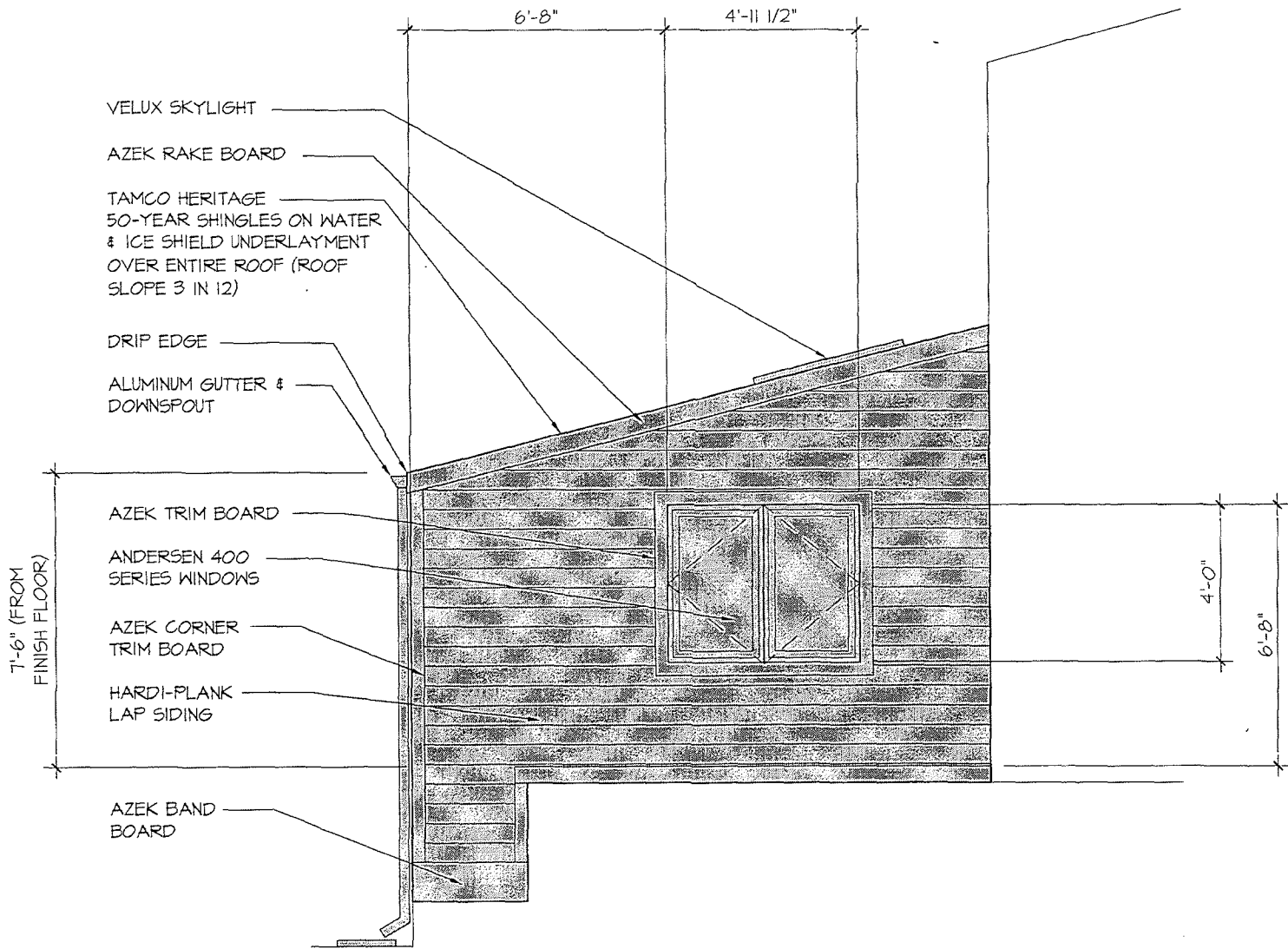

STANDARDS FOR ADDITIONS
EXHIBIT A

UNITS #1 -32

SCALE 1/4" = 1'-0"

DATE 12/02/2005

STREET SIDE DECK ENCLOSURE SHINGLE ROOF - OPTION 2

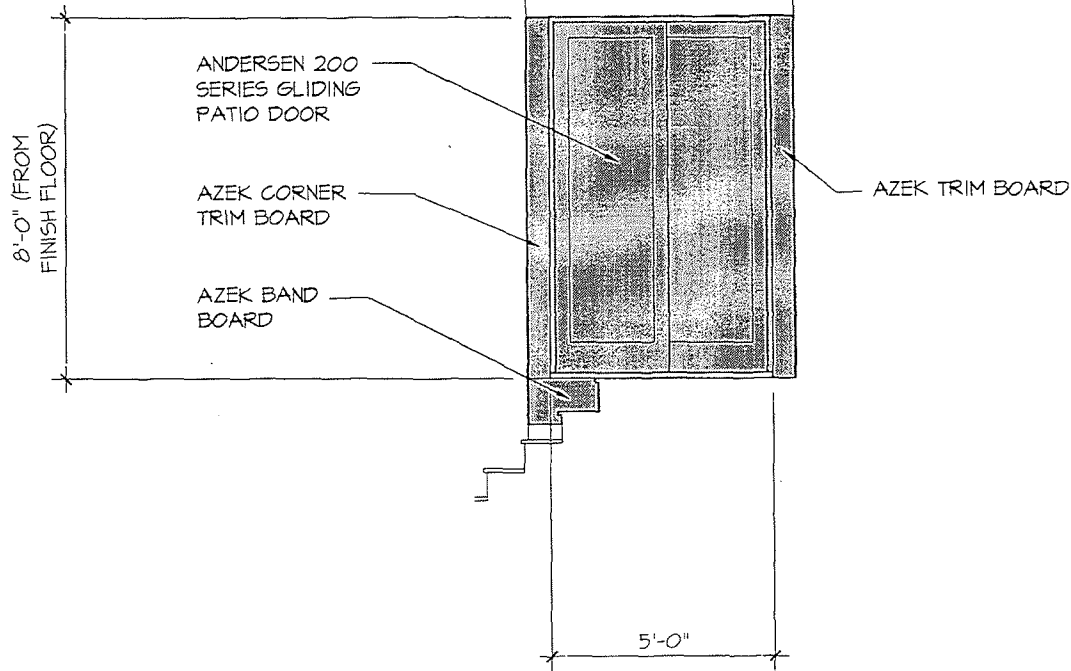

STANDARDS FOR ADDITIONS EXHIBIT A	
UNITS #1 - 32	SCALE: 1/4" = 1'-0"
BEACH SIDE SCREEN PORCH ENCLOSURE - OPTION I	DATE: 12/09/2005

8'-0" (FROM FINISH FLOOR)

- 5'-6"
- ANDERSEN 400 SERIES WINDOWS
- ANDERSEN 400 SERIES WINDOWS
- 2'-6"
- AZEK CORNER TRIM BOARD
- AZEK BAND BOARD

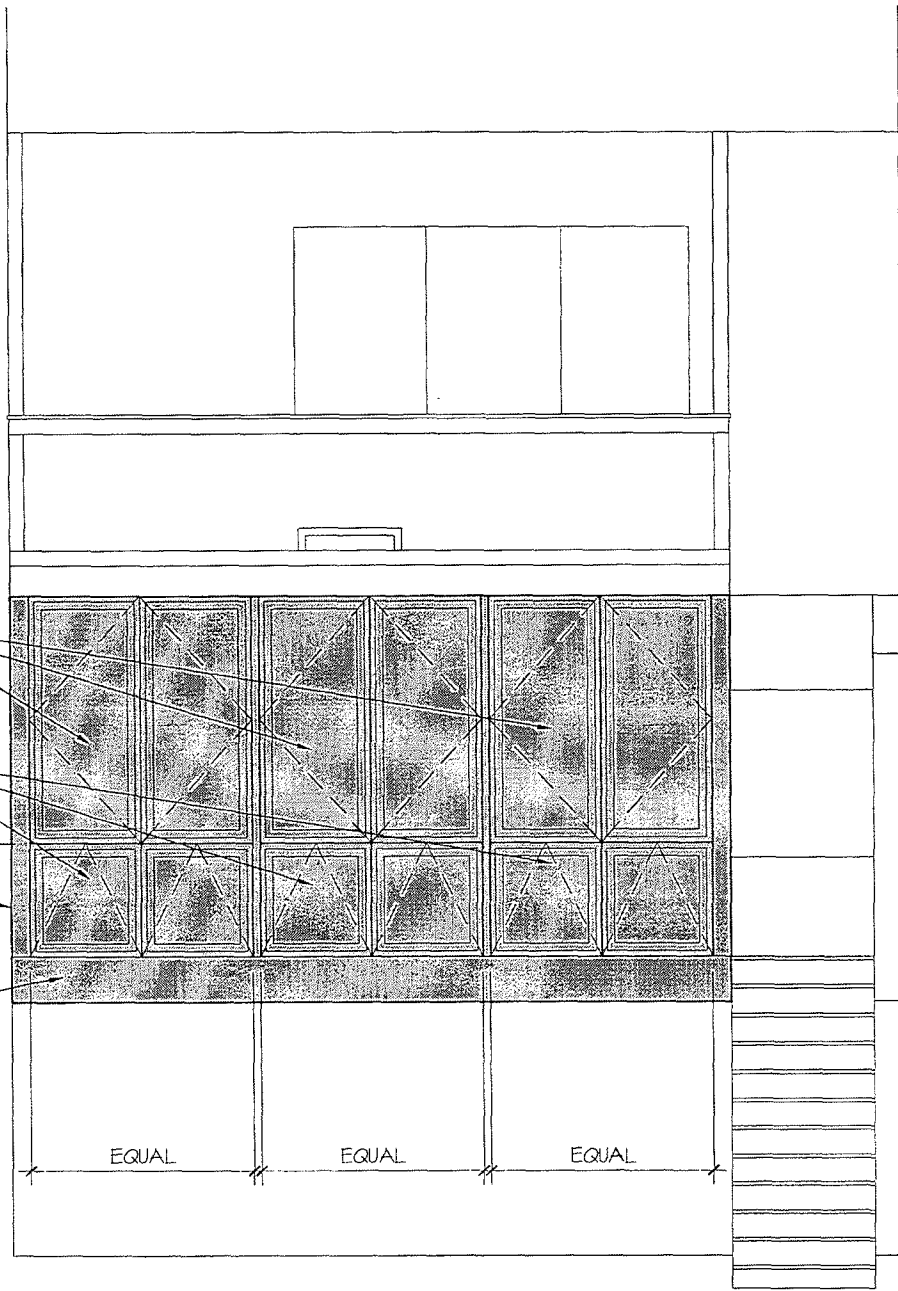

EQUAL

EQUAL

EQUAL

STANDARDS FOR ADDITIONS
EXHIBIT A

UNITS #1 -32
BEACH SIDE SCREEN PORCH ENCLOSURE - OPTION 2

SCALE: 1/4" = 1'-0"
DATE: 12/09/2015

BK: 4505 PG: 325

8'-0" (FROM
FINISH FLOOR)

ANDERSEN 200
SERIES GLIDING
PATIO DOOR

AZEK CORNER
TRIM BOARD

AZEK BAND
BOARD

AZEK TRIM BOARD

5'-0"

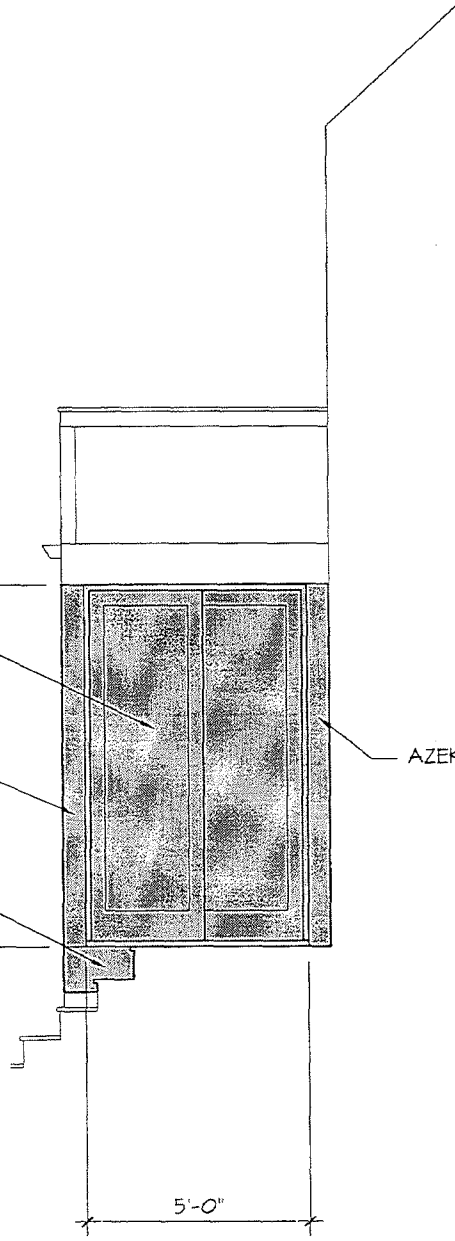

AI

BEACH SIDE SCREEN PORCH ENCLOSURE - OPTION 2

1/4" = 1'-0"

STANDARDS FOR ADDITIONS
EXHIBIT A

UNITS #1 - 32
BEACH SIDE SCREEN PORCH ENCLOSURE - OPTION 2

SCALE: 1/4" = 1'-0"
DATE: 12/02/2015

PAGE

11

1/4" = 1'-0"

AI

BEACH SIDE SCREEN PORCH ENCLOSURE - OPTION 3

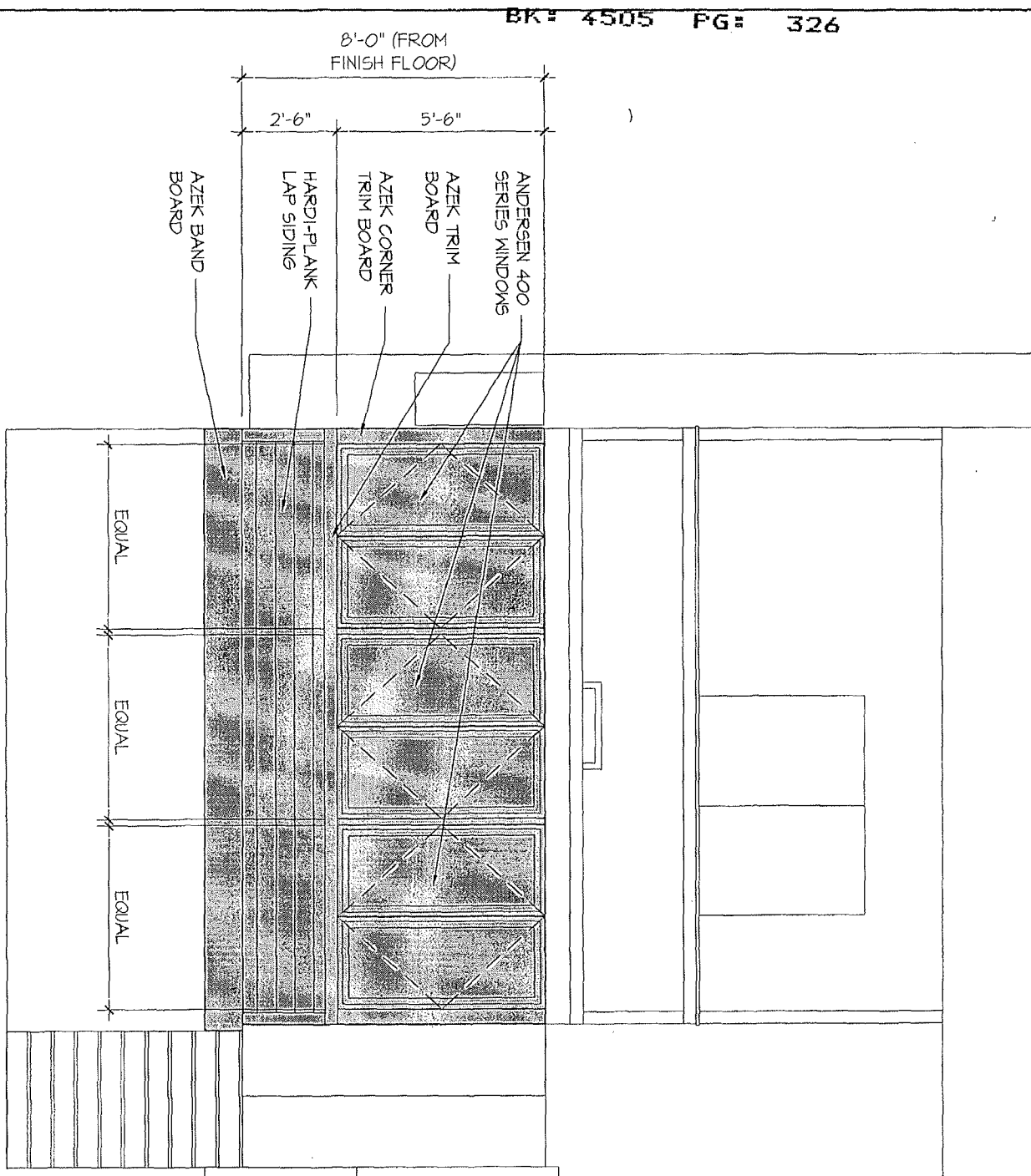

ANDERSEN 400
SERIES WINDOWS

AZEK TRIM
BOARD

AZEK CORNER
TRIM BOARD

HARDI-PLANK
LAP SIDING

AZEK BAND
BOARD

EQUAL

EQUAL

EQUAL

STANDARDS FOR ADDITIONS
EXHIBIT A

UNITS #1 -32

BEACH SIDE SCREEN PORCH ENCLOSURE - OPTION 3

SCALE: 1/4" = 1'-0"

DATE: 12/05/2015

BK= 4505 PG= 327

BK= 4505 PG= 327

8'-0" (FROM
FINISH FLOOR)

5'-6"

2'-6"

ANDERSEN 400
SERIES WINDOWS

HARDI-PLANK
LAP SIDING

AZEK CORNER
TRIM BOARD

AZEK BAND
BOARD

DOOR

AZEK TRIM
BOARD

6'-8" (FROM
FINISH FLOOR)

5'-0"

3'-0"

AI

BEACH SIDE SCREEN PORCH ENCLOSURE - OPTION 3

1/4" = 1'-0"

PAGE

13

STANDARDS FOR ADDITIONS
EXHIBIT A

UNITS #1-32
BEACH SIDE SCREEN PORCH ENCLOSURE - OPTION 3

SCALE: 1/4" = 1'-0"
DATE: 12/02/2005

BK: 4505 PG: 328

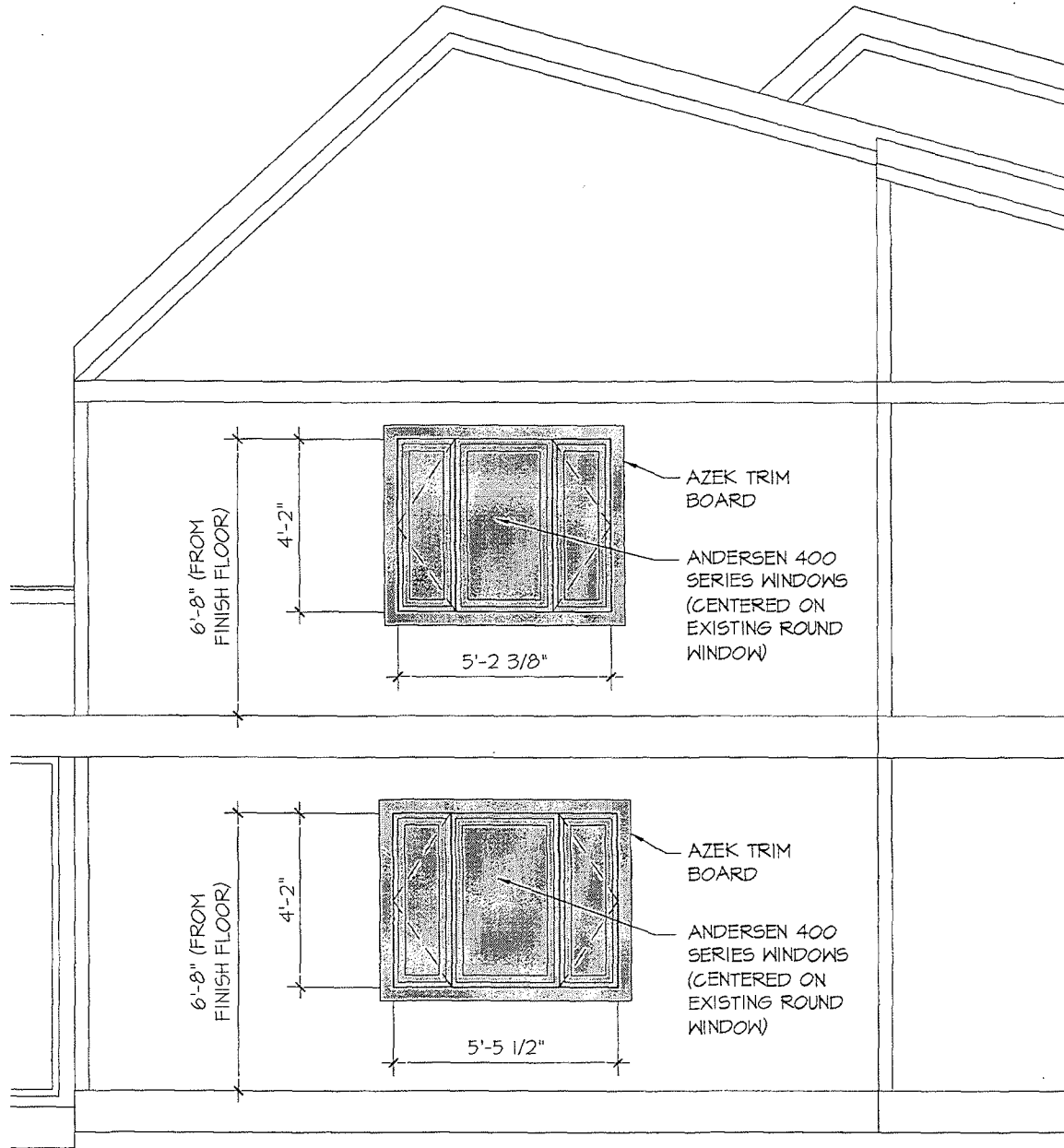

STANDARDS FOR ADDITIONS EXHIBIT A	SCALE: 1/4" = 1'-0"
UNITS #1 -32 REPLACEMENT OF ROUND WINDOWS	DATE: 12/05/2005

BEACH SIDE

BK# 4505 PG# 329

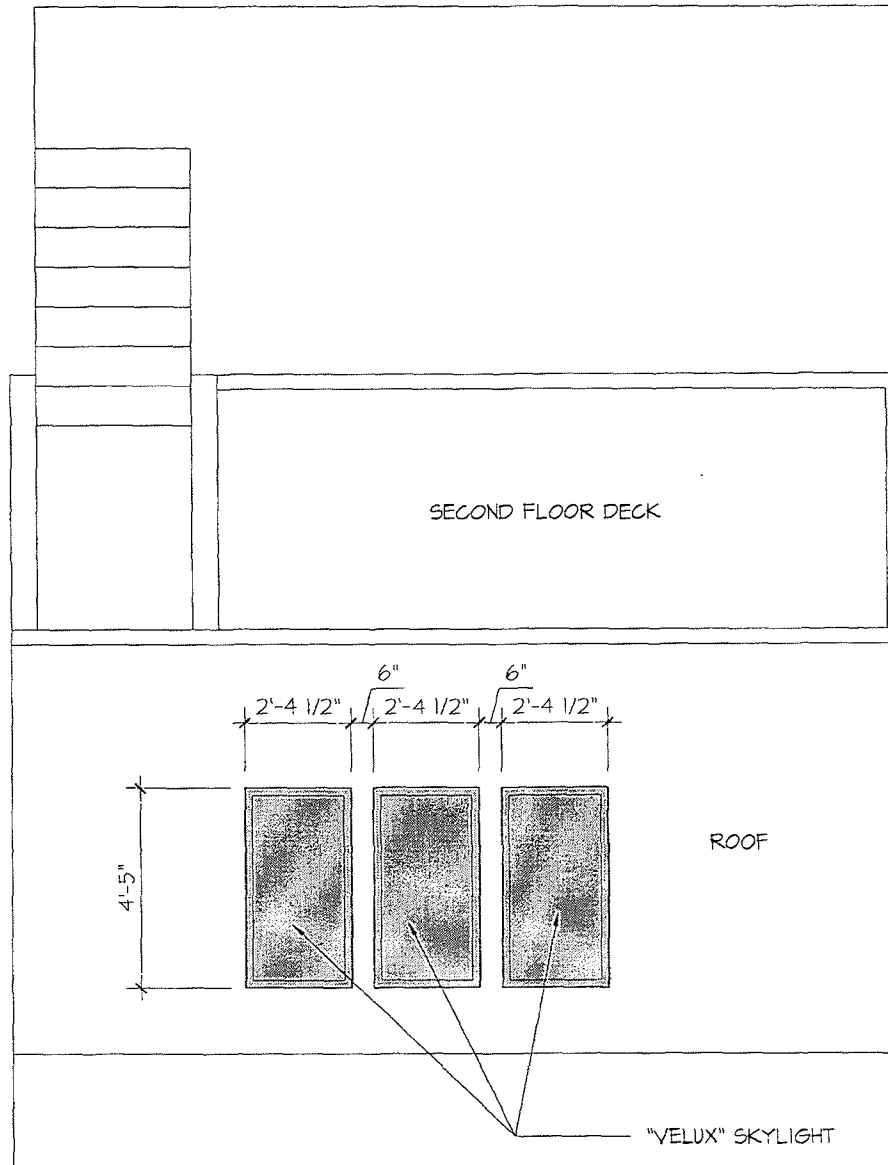

STANDARDS FOR ADDITIONS EXHIBIT A	
UNITS #1 -32 BEACH SIDE ROOF SKYLIGHTS	SCALE: 1/4" = 1'-0" DATE: 12/06/2005

BEACH SIDE

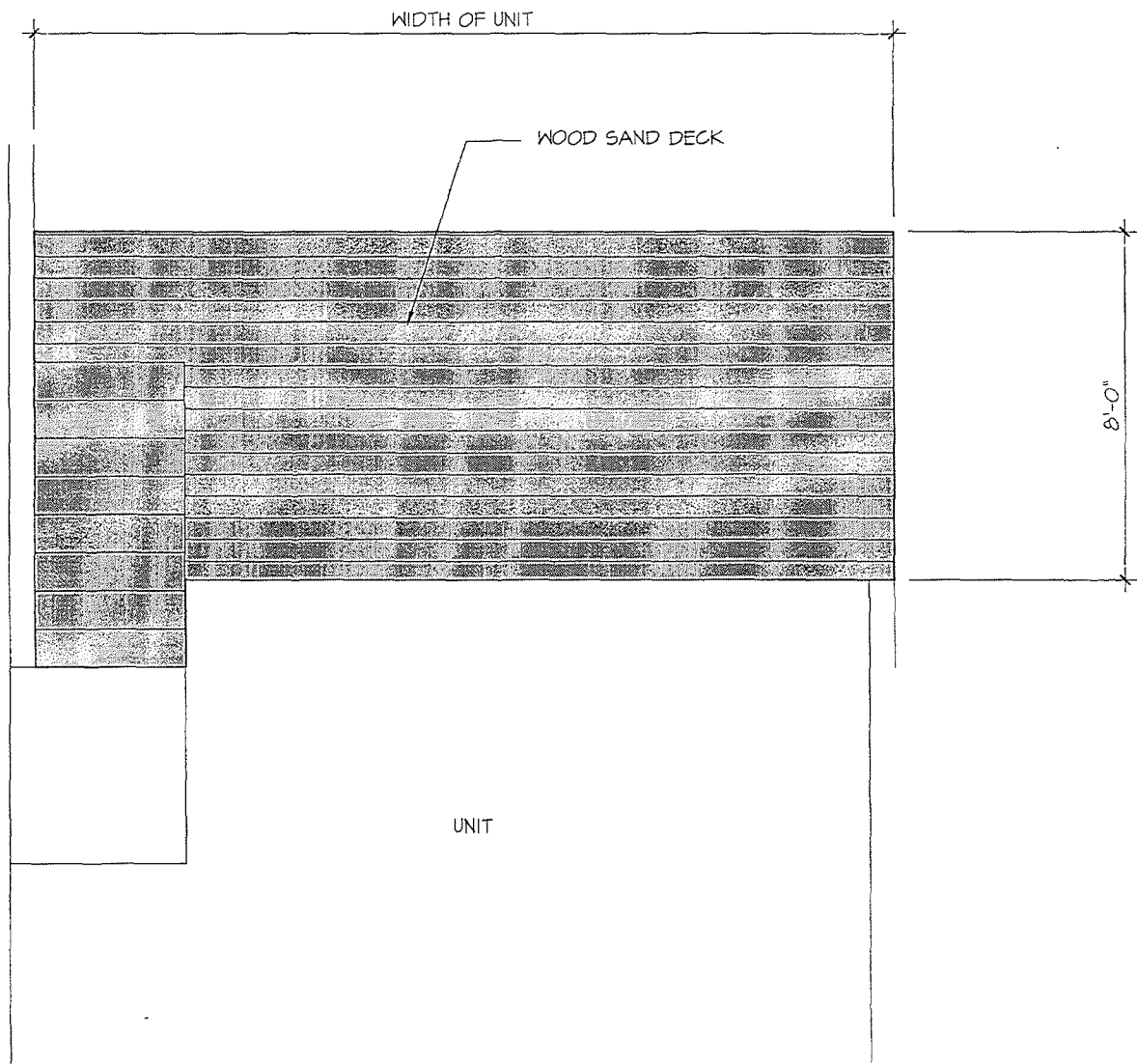

BK: 4505 PG: 330

UNIT

STANDARDS FOR ADDITIONS
EXHIBIT A

UNITS #1 -32
BEACH SIDE SAND DECK

SCALE 1/4" = 1'-0"
DATE 12/07/2005

A1 BEACH SIDE SAND DECK

1/4" = 1'-0"

PAGE 16

BK: 4505 PG: 331

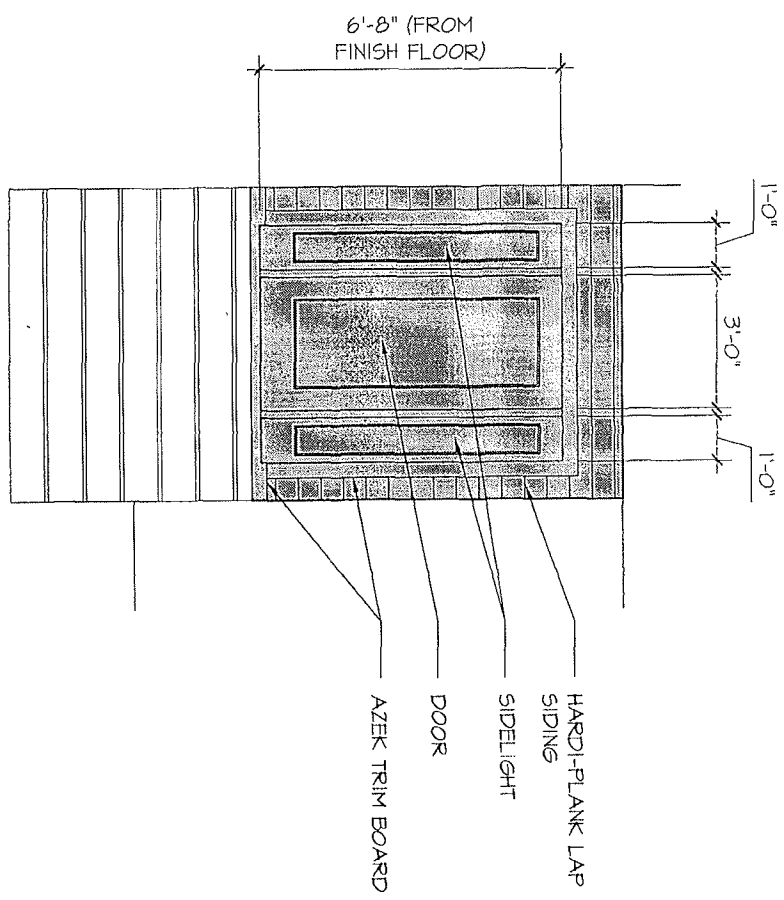

BK: 4505 PG: 332



STANDARDS FOR ADDITIONS EXHIBIT A	
SCALE: 1/4" = 1'-0"	DATE: 12/05/2006
UNITS #1 -32 BEACH SIDE SHOWER ENCLOSURE	

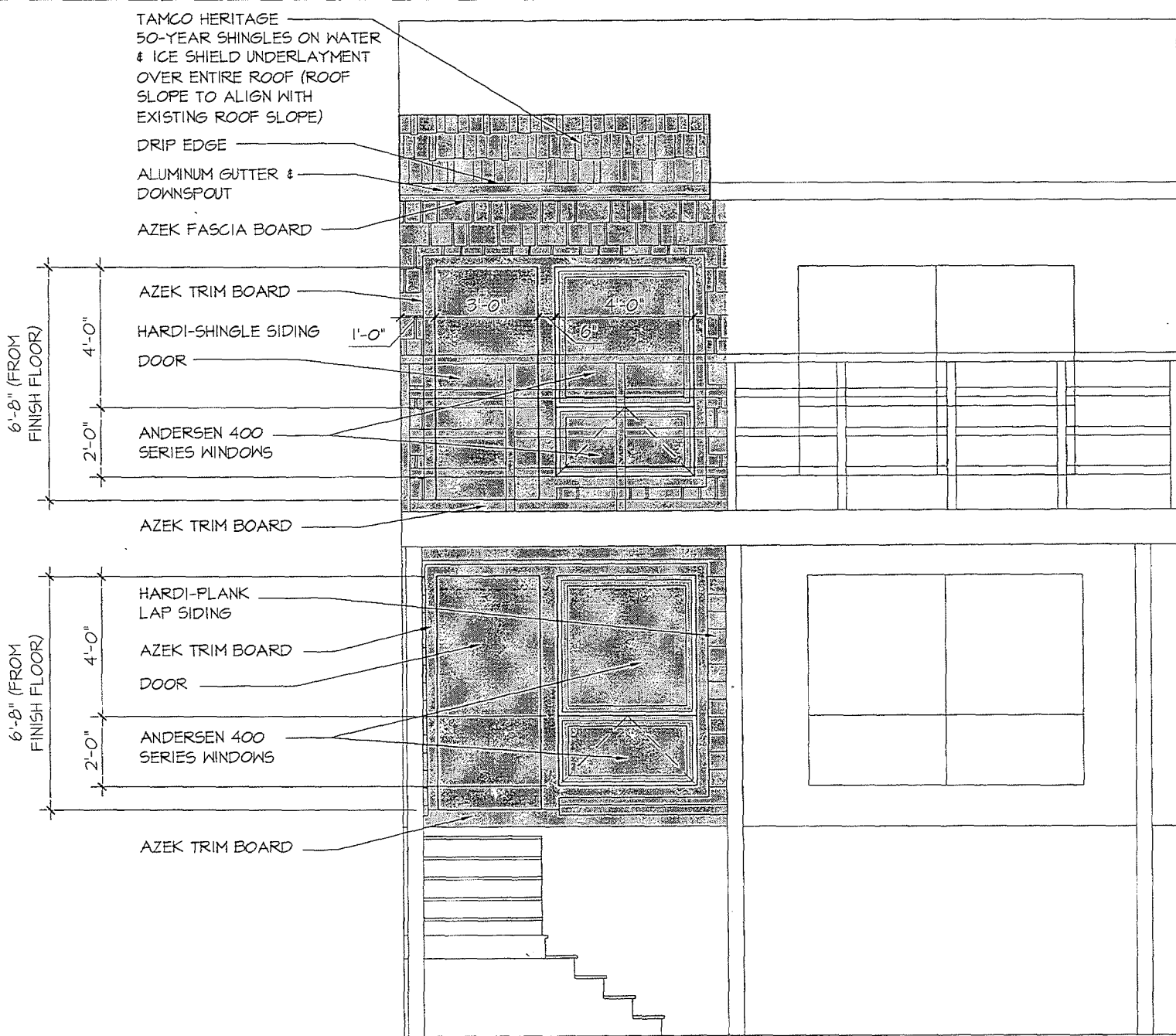

STANDARDS FOR ADDITIONS
 EXHIBIT A
 UNITS #33-46
 BEACH SIDE FIRST & SECOND FLOORS DECK ENCLOSURE - OPTION I

SCALE: 1/4" = 1'-0"
 DATE: 12/02/2015

BK: 4505 PG: 334
 BK: 4505 PG: 334

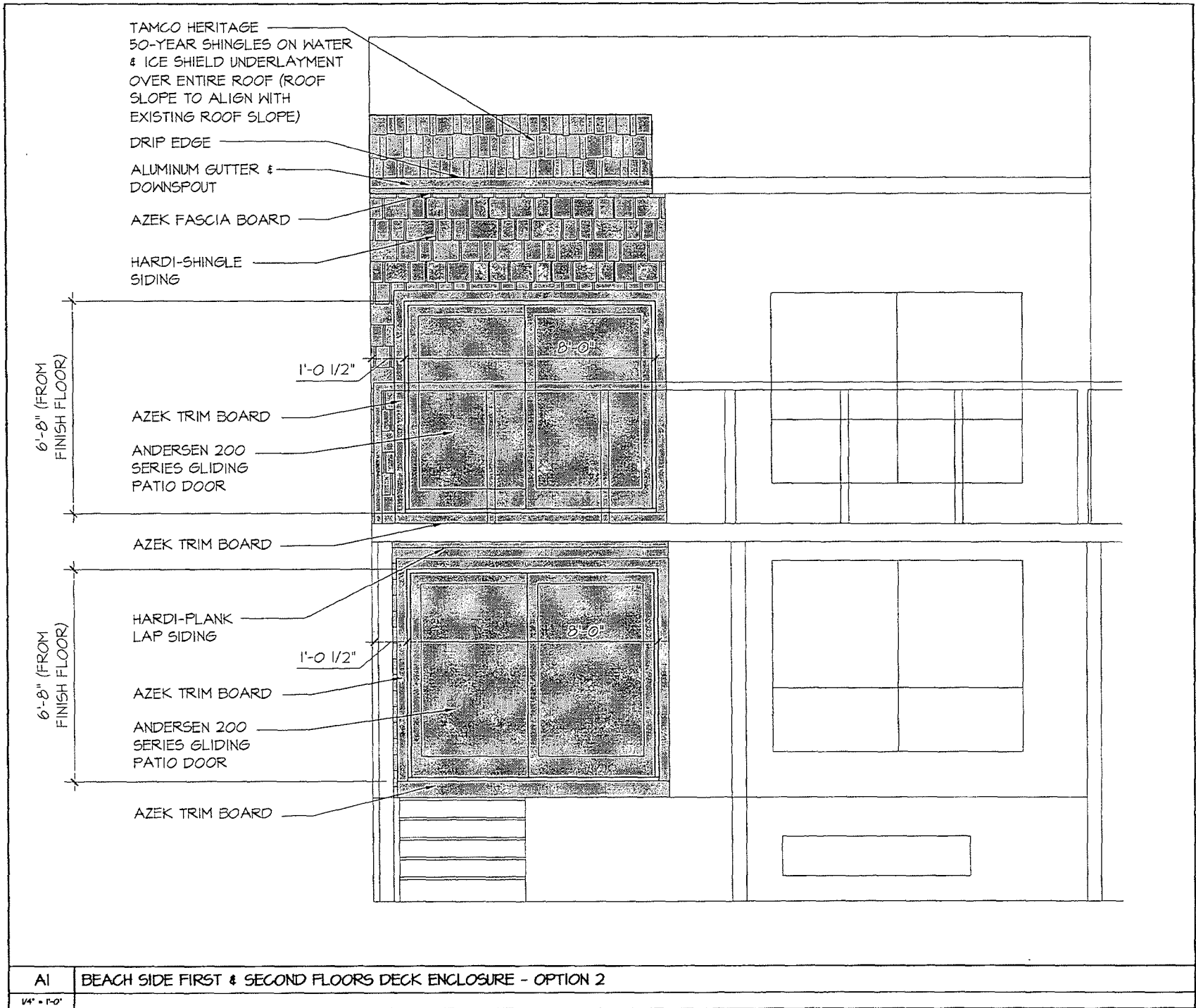

STANDARDS FOR ADDITIONS
 EXHIBIT A

UNITS #33-46
 BEACH SIDE FIRST & SECOND FLOORS DECK ENCLOSURE - OPTION 2

SCALE: 1/4" = 1'-0"
 DATE: 12/05/2003

BEACH SIDE

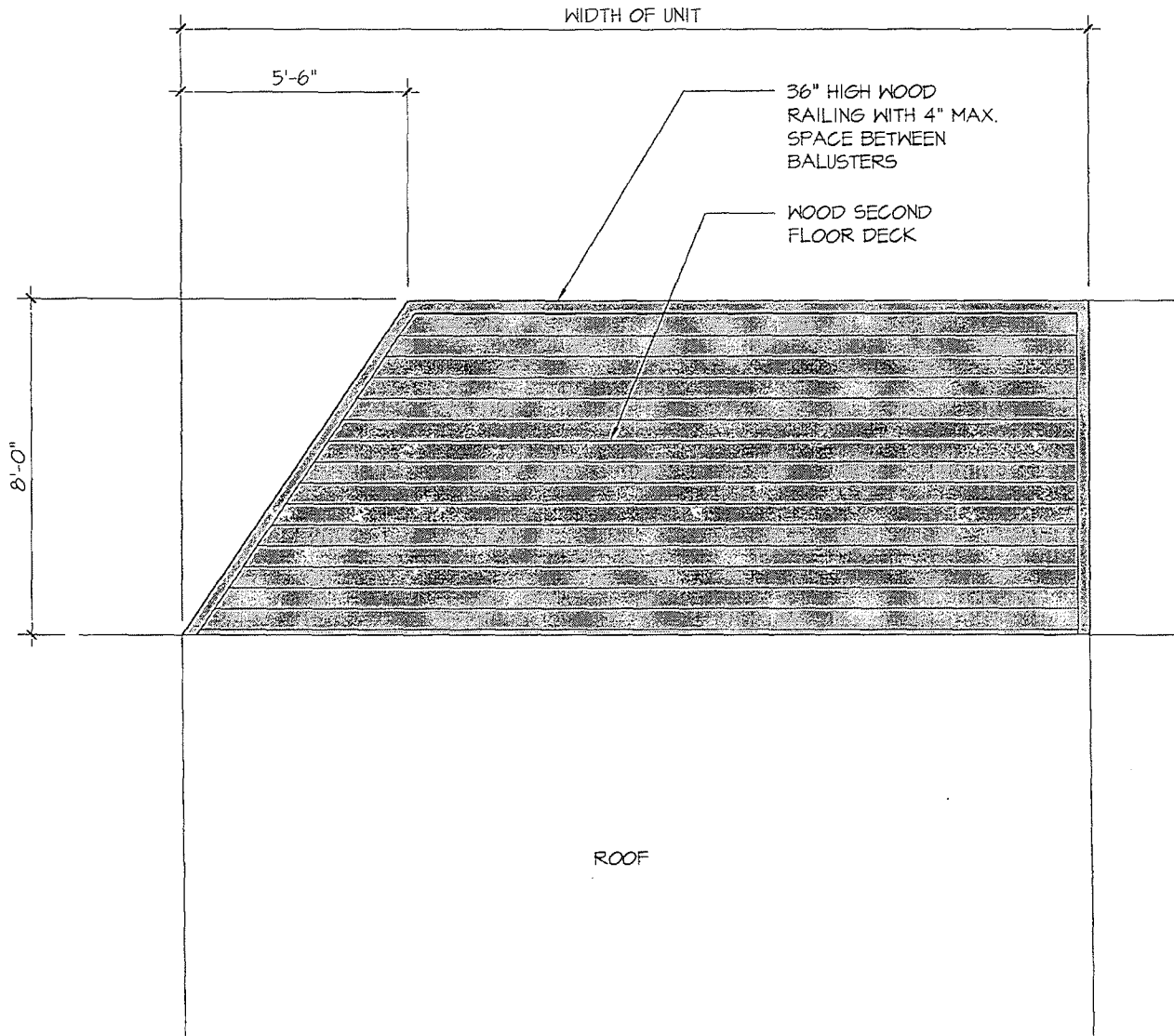

BK: 4505 PG: 335

STANDARDS FOR ADDITIONS	
EXHIBIT A	
SCALE: 1/4" = 1'-0"	DATE: 12/09/03
UNITS #33-46	
BEACH SIDE SECOND FLOOR DECK	

BEACH SIDE

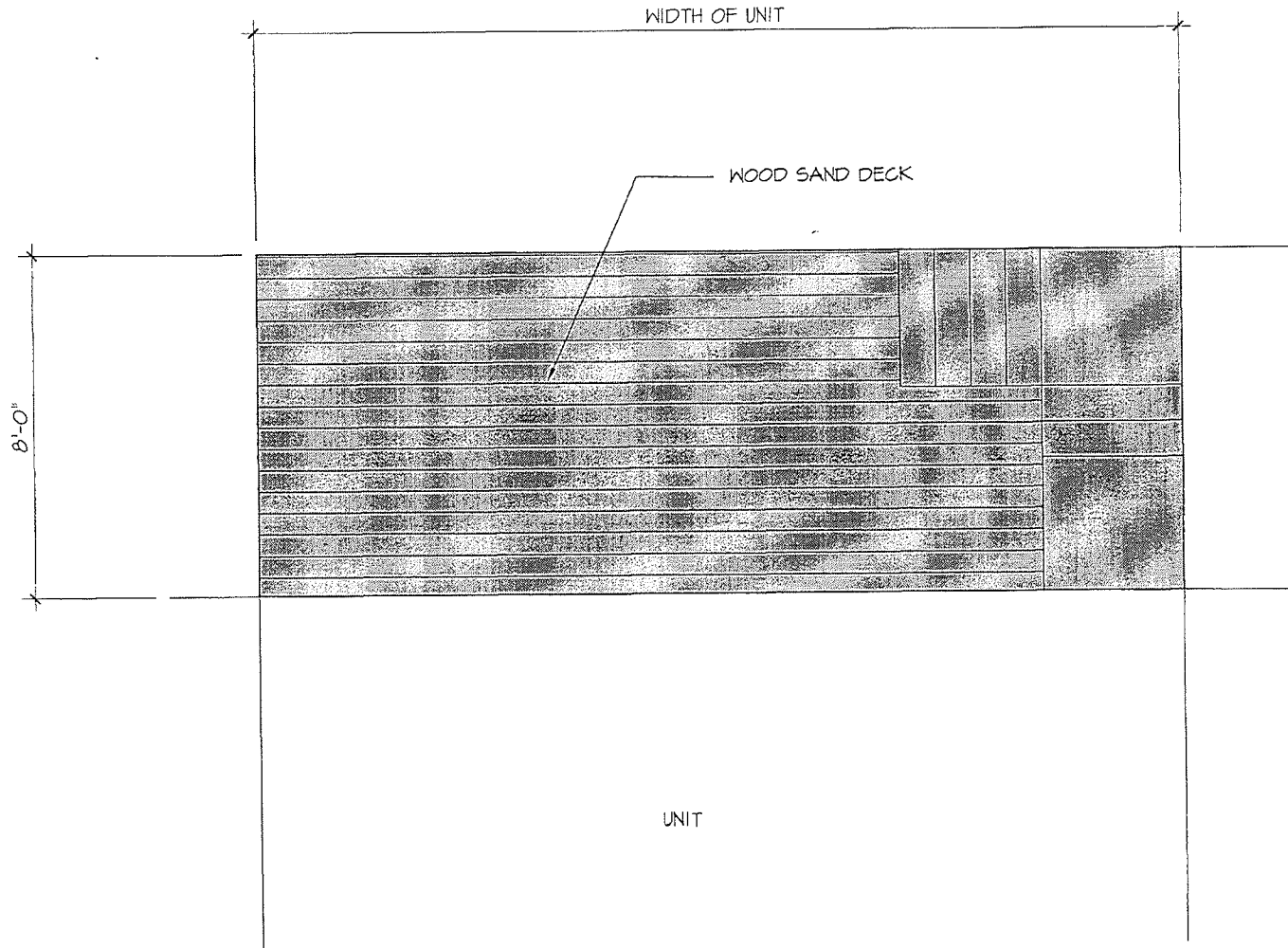

BK: 4505 PG: 336

STANDARDS FOR ADDITIONS EXHIBIT A	SCALE: 1/4" = 1'-0" DATE: 12/09/2009
UNITS #33-46 BEACH SIDE SAND DECK	

BEACH SIDE

SECOND FLOOR DECK

BK: 4505 FG: 337

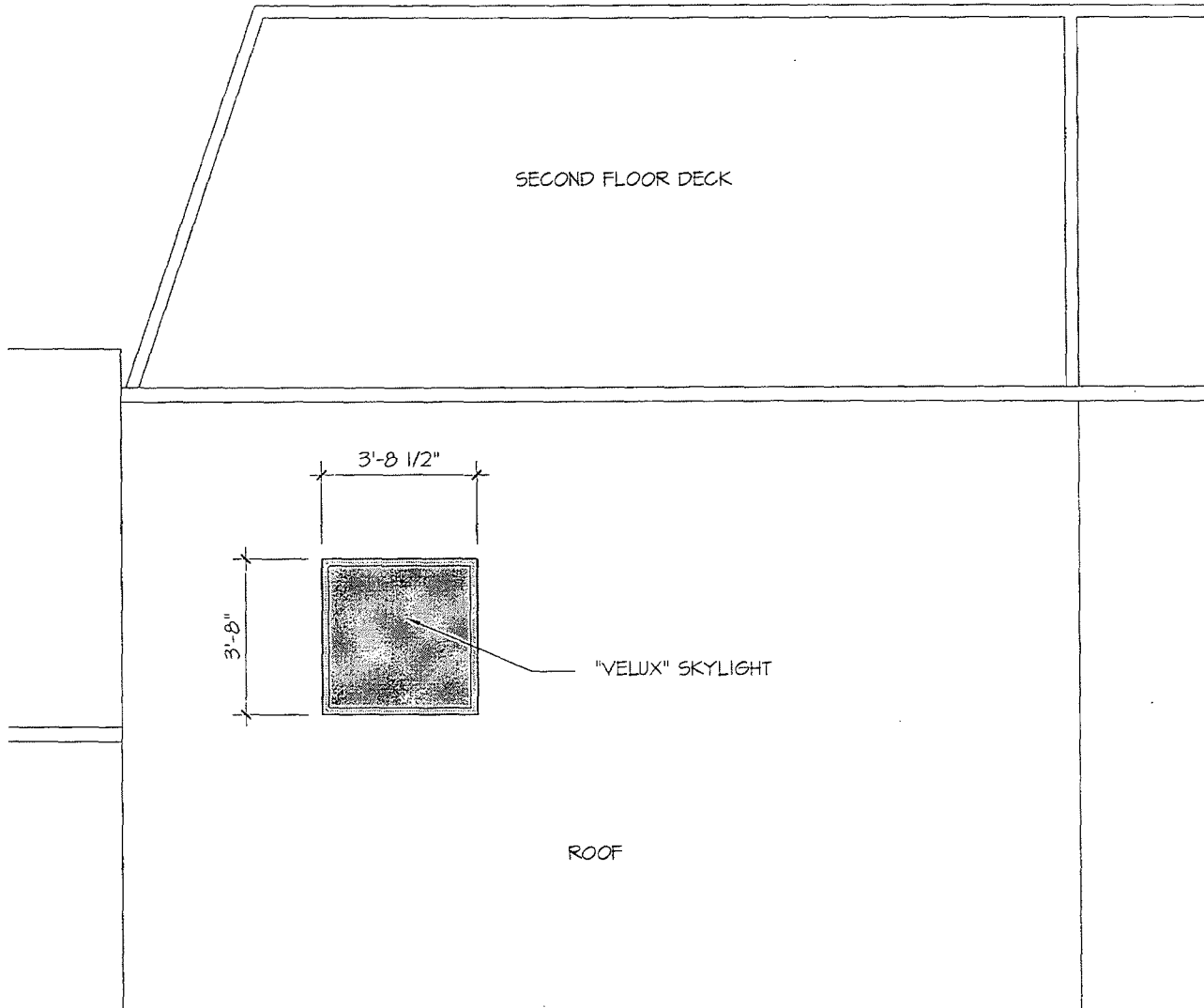

STANDARDS FOR ADDITIONS EXHIBIT A	
UNITS #33-46 BEACH SIDE ROOF SKY LIGHT	SCALE: 1/4" = 1'-0" DATE: 12/04/2005

AI
END UNIT WINDOWS
1/4" = 1'-0"

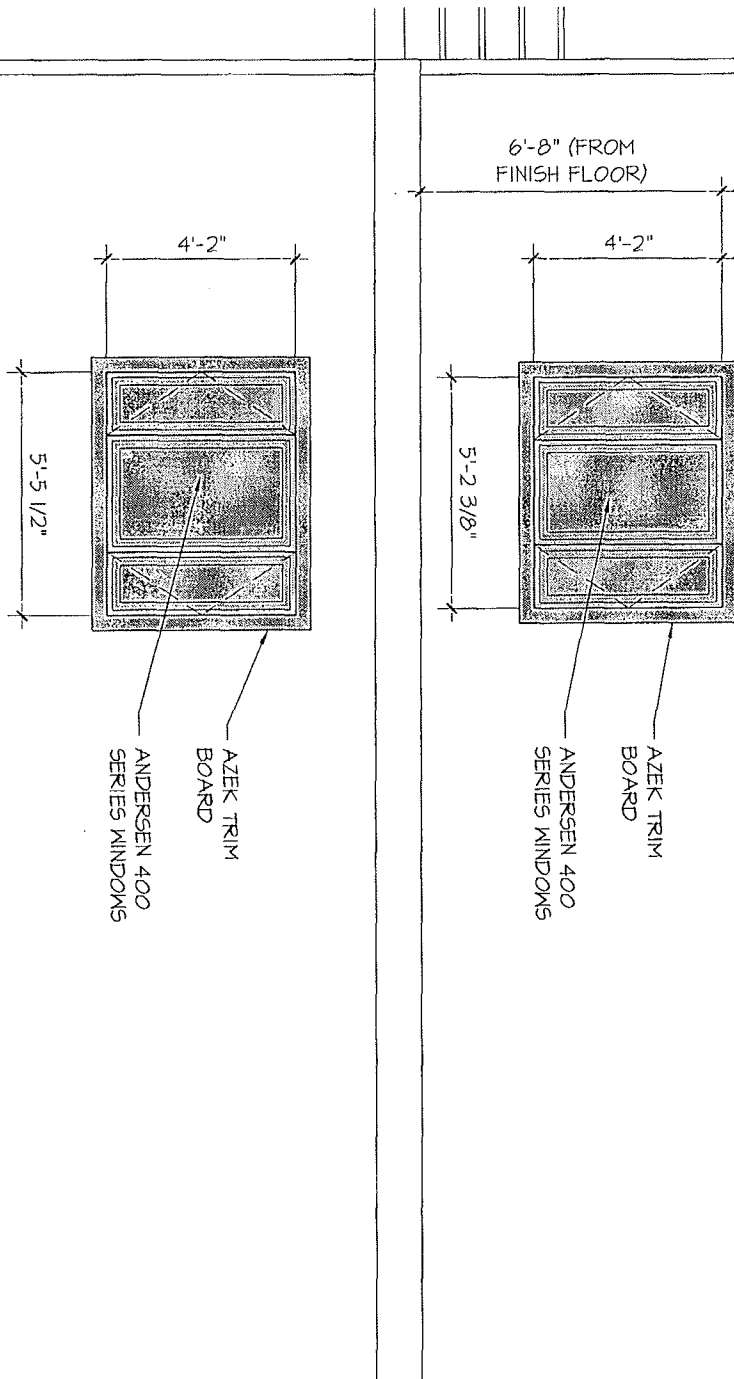

STANDARDS FOR ADDITIONS EXHIBIT A	
UNITS #33-46 END UNIT WINDOWS	SCALE: 1/4" = 1'-0" DATE: 12/05/2015

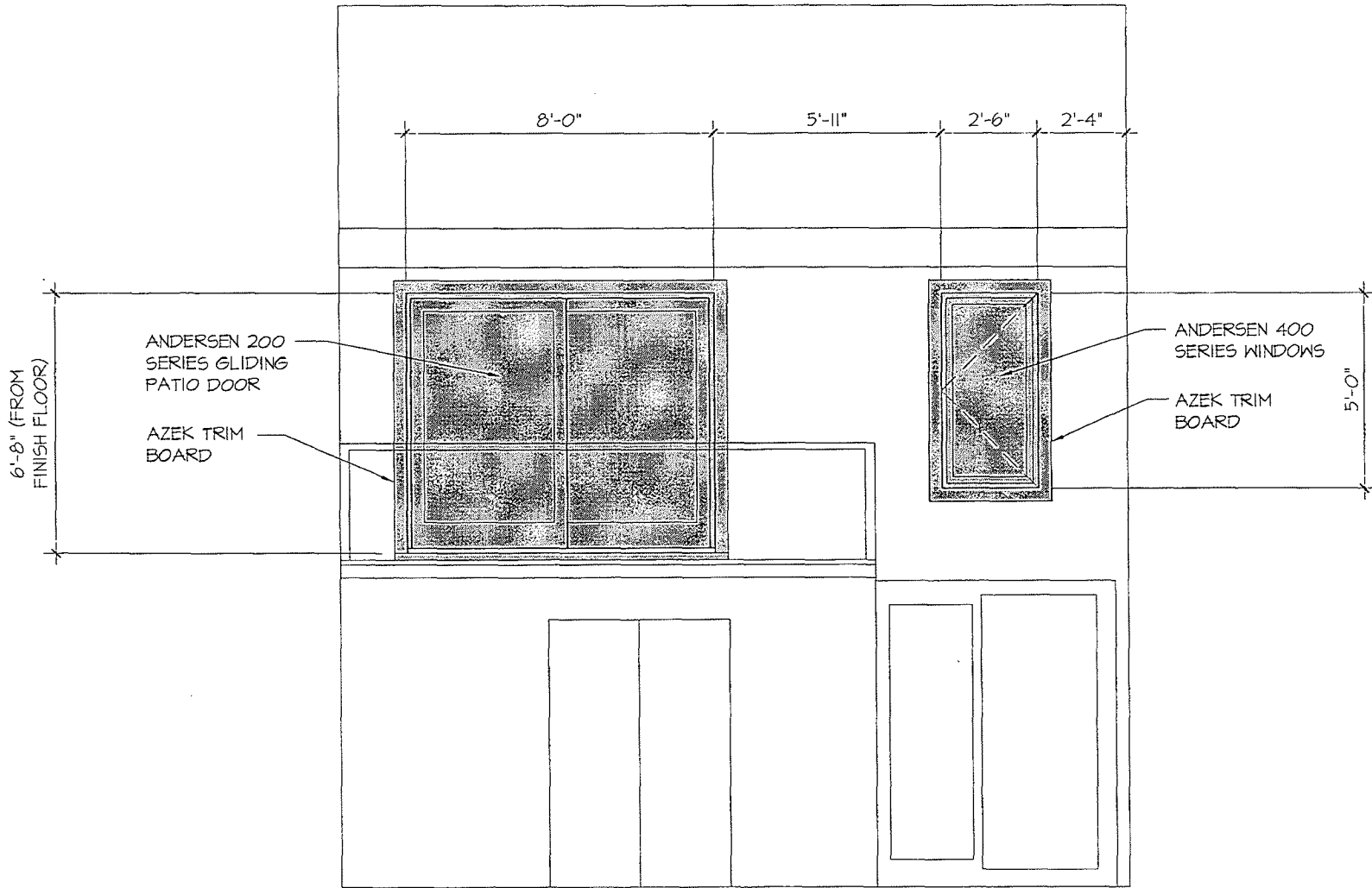

STANDARDS FOR ADDITIONS
 EXHIBIT A
 UNITS #47-60
 STREET SIDE SECOND FLOOR ELEVATION - OPTION I

SCALE: 1/4" = 1'-0"
 DATE: 12/02/05

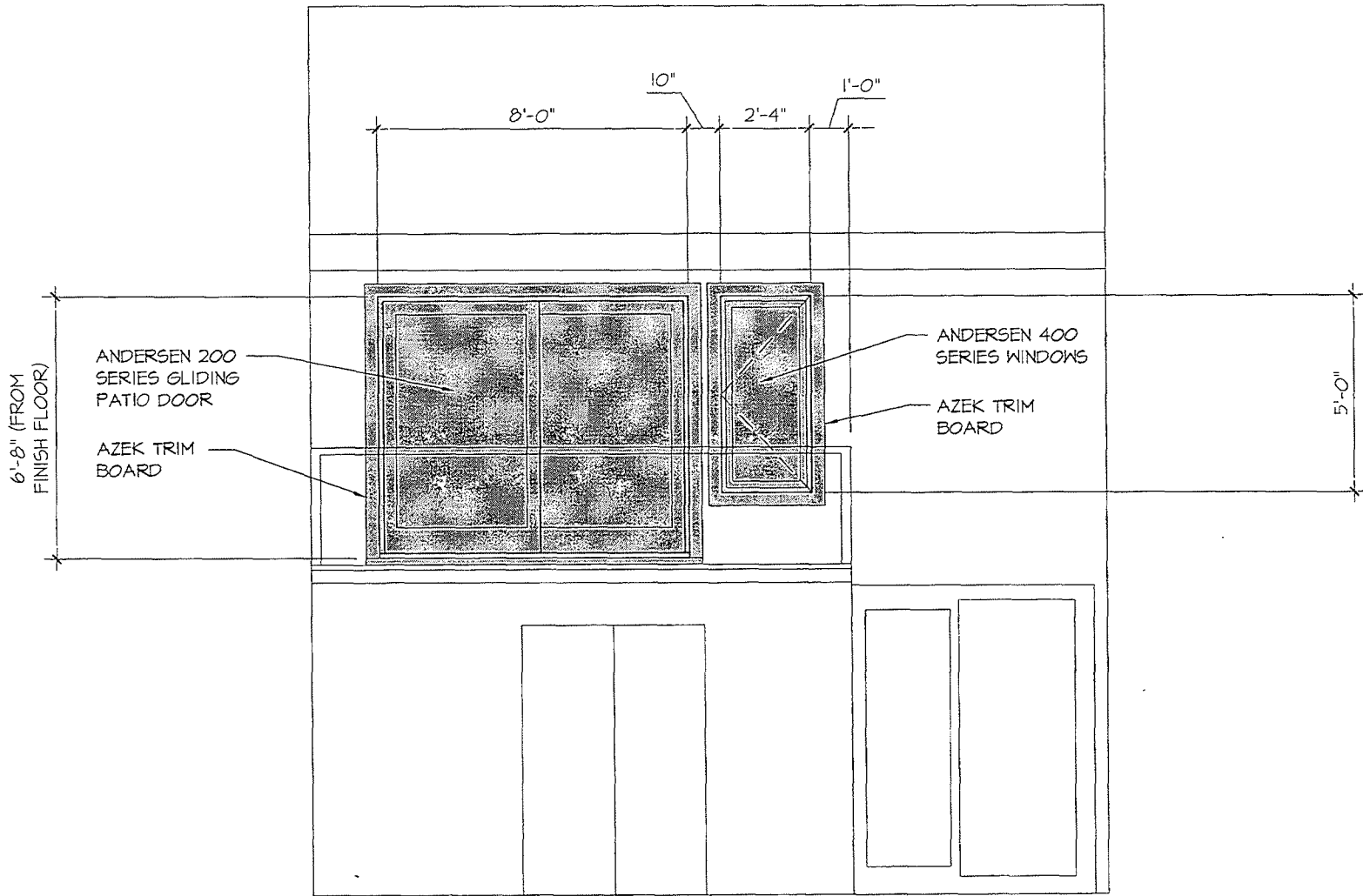

STANDARDS FOR ADDITIONS EXHIBIT A	
SCALE: 1/4" = 1'-0"	DATE: 12/29/2005
UNITS #47-60 STREET SIDE SECOND FLOOR ELEVATION - OPTION 3	

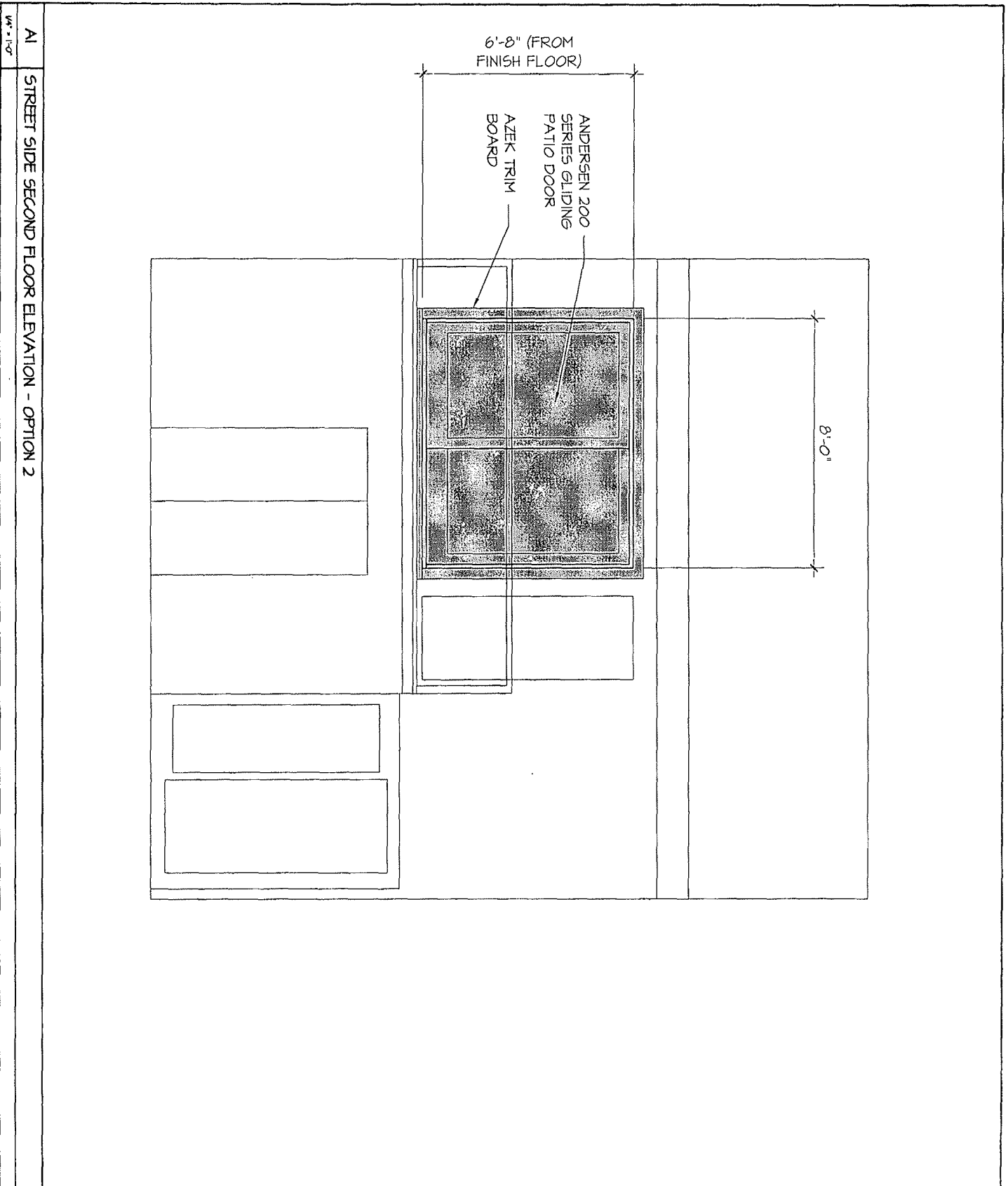

1/4" = 1'-0"
A1
STREET SIDE SECOND FLOOR ELEVATION - OPTION 2

STANDARDS FOR ADDITIONS EXHIBIT A	
UNITS #47-60 STREET SIDE SECOND FLOOR ELEVATION - OPTION 2	
SCALE: 1/4" = 1'-0"	DATE: 12/05/2005

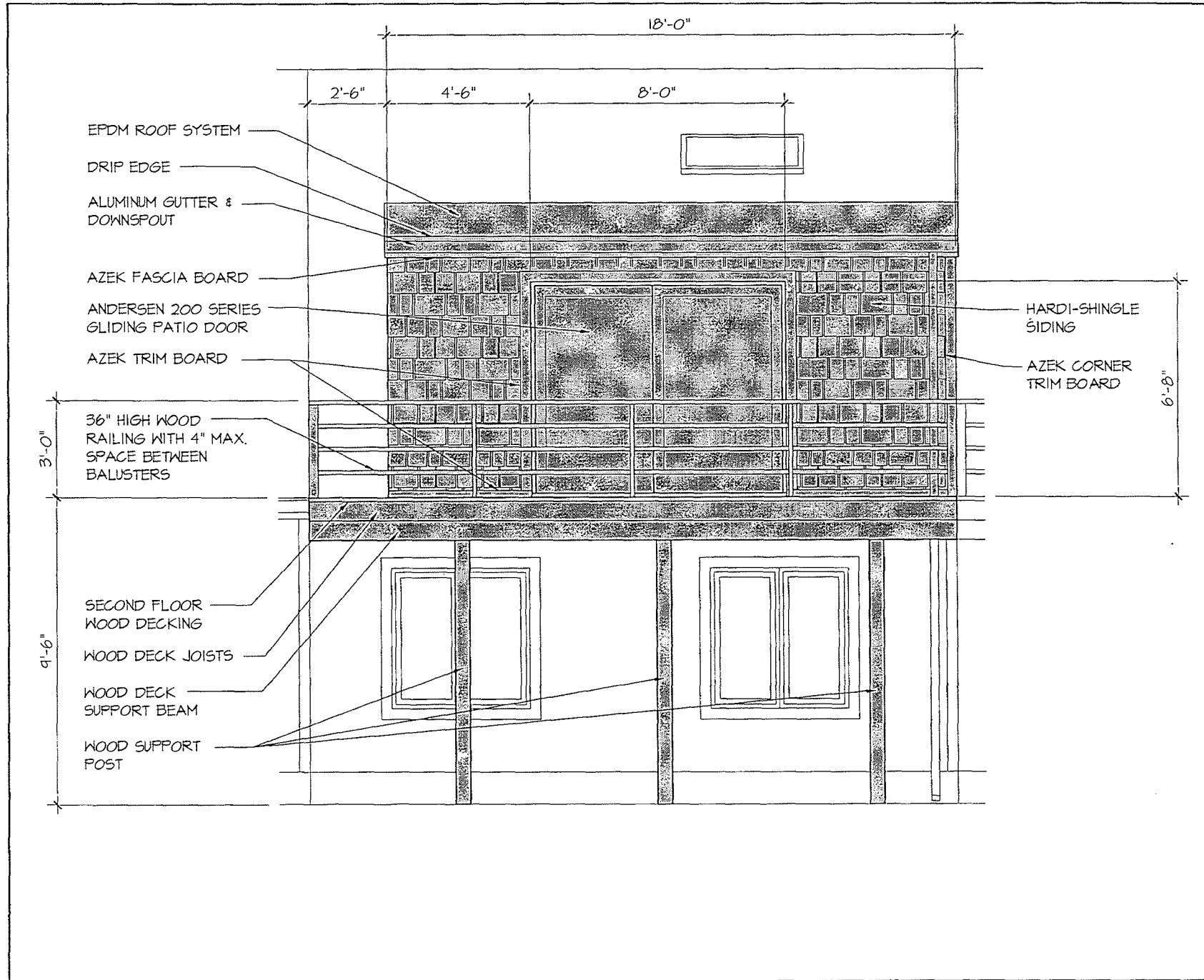

STANDARDS FOR ADDITIONS
EXHIBIT A

UNITS #41-60
REAR ROOM & DECK ADDITION

SCALE: 1/4" = 1'-0"
DATE: 12/09/2009

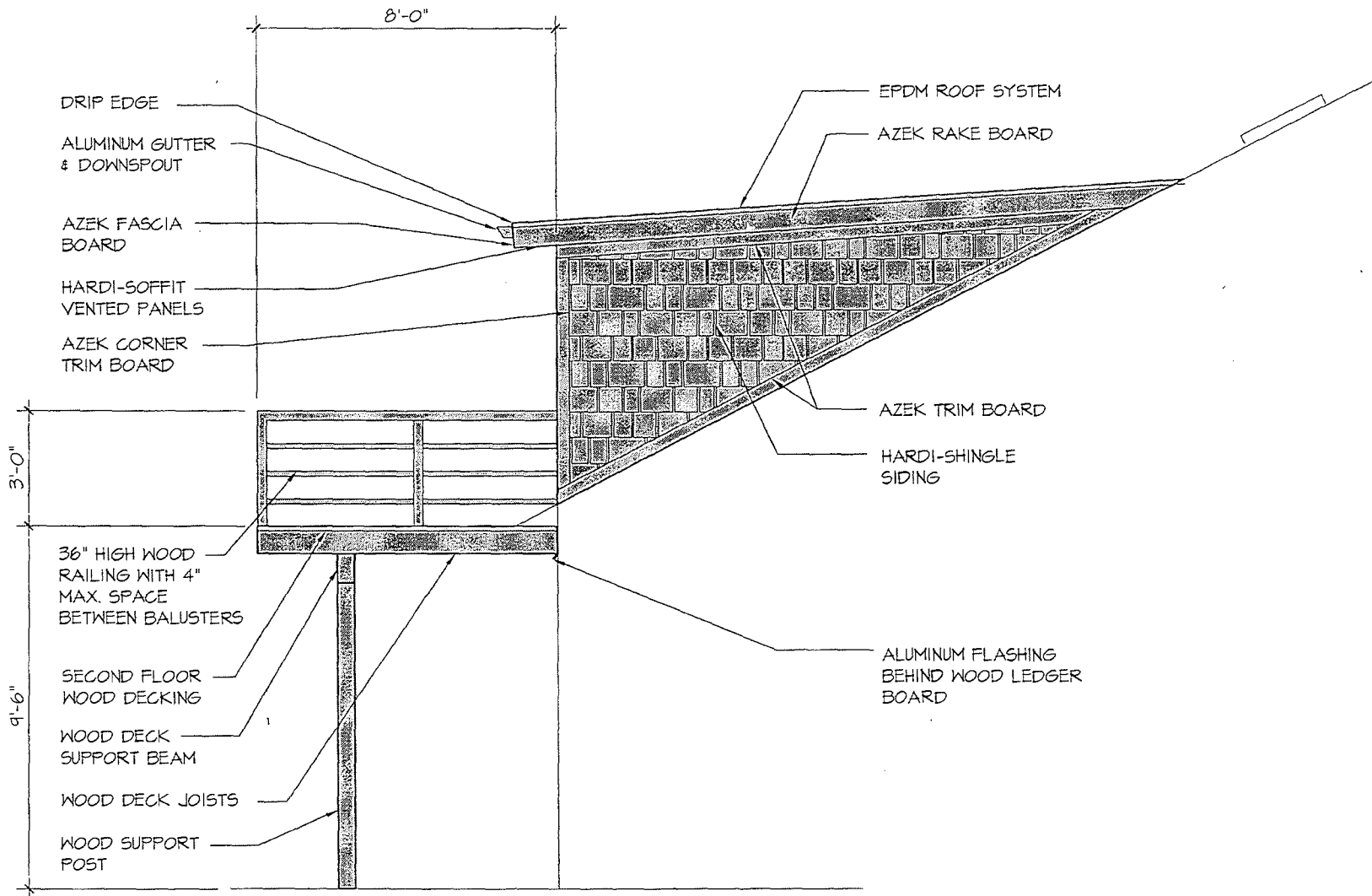

STANDARDS FOR ADDITIONS
EXHIBIT A

UNITS #47-60
REAR ROOM & DECK ADDITION

SCALE: 1/4" = 1'-0"
DATE: 12/07/08

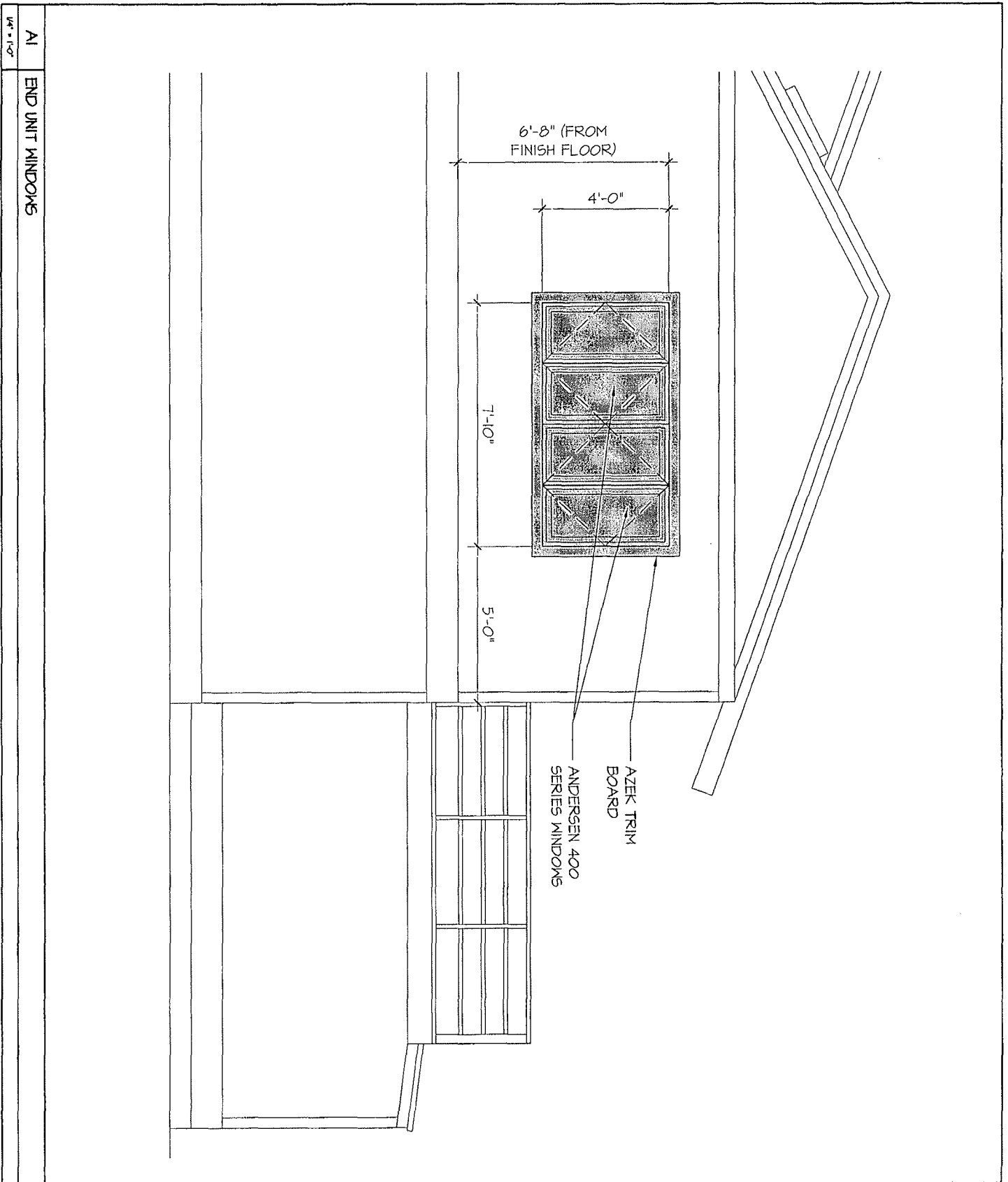

AI
END UNIT WINDOWS
1/4" = 1'-0"

30

STANDARDS FOR ADDITIONS
EXHIBIT A

UNITS #47-60
END UNIT WINDOWS

SCALE: 1/4" = 1'-0"
DATE: 12/05/2005

BK: 4505 PG: 345

AZEK TRIM BOARD

ALUMINUM GUTTER &
DOWNSPOUT

AZEK CORNER BOARD

DOOR

ANDERSEN 400
SERIES WINDOW

HARDI-PLANK
LAP SIDING

AZEK BAND BOARD

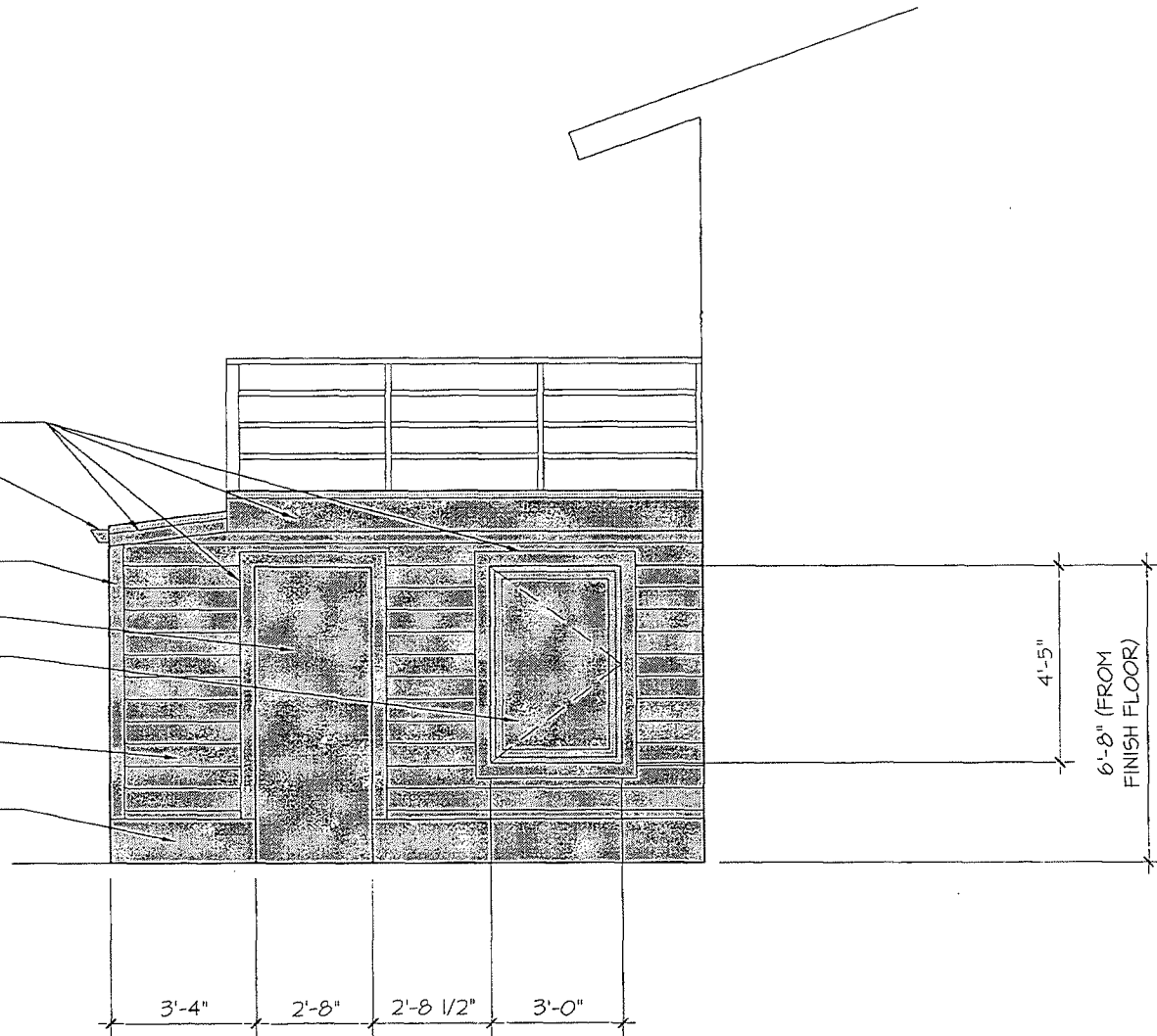

STANDARDS FOR ADDITIONS EXHIBIT A	
UNITS #41-60	SCALE: 1/4" = 1'-0"
STREET SIDE FIRST FLOOR PATIO ENCLOSURE	
DATE: 12/07/2015	

1/4" = 1'-0"

AI

STREET SIDE FIRST FLOOR PATIO ENCLOSURE

6'-8" (FROM FINISH FLOOR)

BK: 4505 PG: 346

RECEIVED
FEB 12, 2016
ASSESSMENT DIVISION
SUSSEX COUNTY

- AZEK BAND BOARD
- HARDI-PLANK LAP SIDING
- DOOR
- AZEK CORNER BOARD
- ALUMINUM GUTTER & DOWNSPUT
- AZEK BOARD

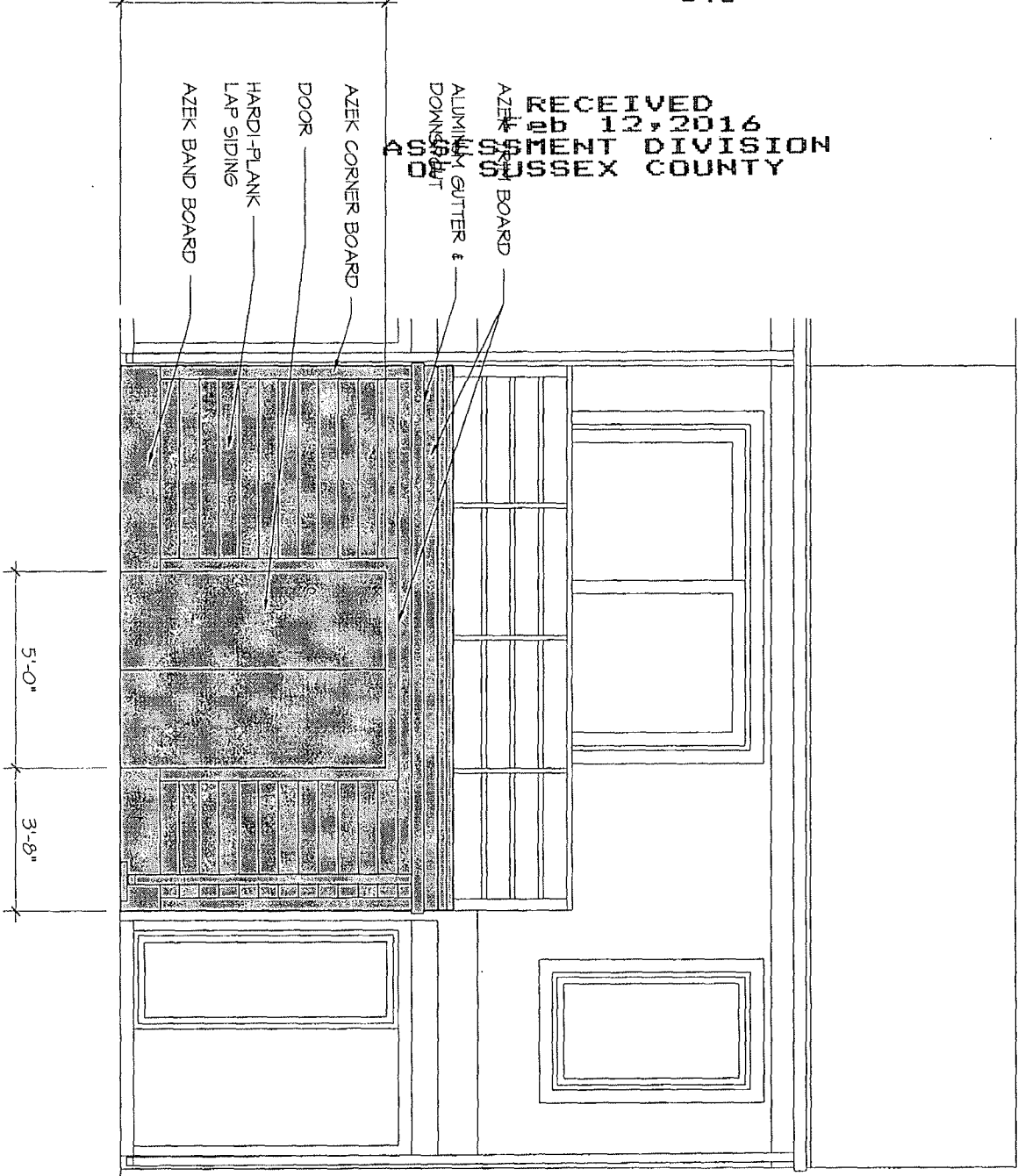

Recorder of Deeds
Scott Dailey
Feb 12, 2016 01:38P
Sussex County
Doc. Surcharge Paid

STANDARDS FOR ADDITIONS
EXHIBIT A

UNITS #41-60
STREET SIDE FIRST FLOOR PATIO ENCLOSURE

SCALE: 1/4" = 1'-0"
DATE: 12/09/2015